

IND131/IND331

Terminals

User's Guide

© METTLER TOLEDO 2009

No part of this manual may be reproduced or transmitted in any form or by any means, electronic or mechanical, including photocopying and recording, for any purpose without the express written permission of METTLER TOLEDO.

U.S. Government Restricted Rights: This documentation is furnished with Restricted Rights.

Copyright 2009 METTLER TOLEDO. This documentation contains proprietary information of METTLER TOLEDO. It may not be copied in whole or in part without the express written consent of METTLER TOLEDO.

METTLER TOLEDO reserves the right to make refinements or changes to the product or manual without notice.

COPYRIGHT

METTLER TOLEDO® is a registered trademark of Mettler-Toledo, Inc. All other brand or product names are trademarks or registered trademarks of their respective companies.

METTLER TOLEDO RESERVES THE RIGHT TO MAKE REFINEMENTS OR CHANGES WITHOUT NOTICE.

FCC Notice

This device complies with Part 15 of the FCC Rules and the Radio Interference Requirements of the Canadian Department of Communications. Operation is subject to the following conditions: (1) this device may not cause harmful interference, and (2) this device must accept any interference received, including interference that may cause undesired operation.

This equipment has been tested and found to comply with the limits for a Class A digital device, pursuant to Part 15 of FCC Rules. These limits are designed to provide reasonable protection against harmful interference when the equipment is operated in a commercial environment. This equipment generates, uses, and can radiate radio frequency energy and, if not installed and used in accordance with the instruction manual, may cause harmful interference to radio communications. Operation of this equipment in a residential area is likely to cause harmful interference in which case the user will be required to correct the interference at his or her expense.

◀ Declaration of Conformity is located on the documentation CD.

NOTE ON FIRMWARE VERSION

This manual describes features and functions of the IND131 and IND331 terminals with version 1.xx firmware. Terminals with a different version of firmware will differ in some areas.

RoHS Compliance Statement.

- The majority of our products fall within categories 8 and 9. Those categories currently do not fall within the scope of the Directive 2002/95/EG (RoHS) of January 27, 2003. If our products are intended for use in other products which themselves fall within the scope of the RoHS Directive, compliance requirements have to be separately negotiated contractually.
- Those products which fall within categories 1-7 and 10 will be in compliance with the EU RoHS Directive from no later than July 1, 2006.
- If it is not possible for technical reasons to replace any non-RoHS-compliant substances in any of the above products as required, we plan to inform our customers in a timely manner

Statement regarding harmful substances

We do not make direct use of harmful materials such as asbestos, radioactive substances or arsenic compounds. However, we purchase components from third party suppliers, which may contain some of these substances in very small quantities.

FOLD THIS FLAP FIRST



NO POSTAGE
NECESSARY
IF MAILED IN THE
UNITED STATES

BUSINESS REPLY MAIL
FIRST CLASS PERMIT NO. 414 COLUMBUS, OH

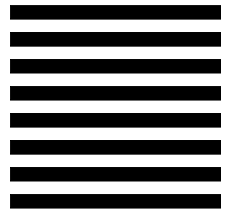

POSTAGE WILL BE PAID BY ADDRESSEE



Mettler-Toledo, Inc.
Quality Manager - MTWT
P.O. Box 1705
Columbus, OH 43216
USA

Please seal with tape



PRECAUTIONS

- READ this manual BEFORE operating or servicing this equipment and FOLLOW these instructions carefully.
- SAVE this manual for future reference.

	 WARNING!
	FOR CONTINUED PROTECTION AGAINST SHOCK HAZARD CONNECT THE AC VERSION OF THE HARSH AND JUNCTION BOX ENCLOSURES TO PROPERLY GROUNDED OUTLET ONLY. DO NOT REMOVE THE GROUND PRONG.

	 WARNING!
	DO NOT USE THE IND131 OR IND331 TERMINALS IN AREAS CLASSIFIED AS HAZARDOUS BECAUSE OF COMBUSTIBLE OR EXPLOSIVE ATMOSPHERES. CONTACT AN AUTHORIZED METTLER TOLEDO REPRESENTATIVE FOR INFORMATION ABOUT HAZARDOUS AREA APPLICATIONS.

	 WARNING!
	WHEN THIS EQUIPMENT IS INCLUDED AS A COMPONENT PART OF A SYSTEM, THE RESULTING DESIGN MUST BE REVIEWED BY QUALIFIED PERSONNEL WHO ARE FAMILIAR WITH THE CONSTRUCTION AND OPERATION OF ALL COMPONENTS IN THE SYSTEM AND THE POTENTIAL HAZARDS INVOLVED. FAILURE TO OBSERVE THIS PRECAUTION COULD RESULT IN BODILY HARM AND/OR PROPERTY DAMAGE.

	 WARNING!
	ENSURE THAT THE POWER CONNECTION TO THE IND131 OR IND331 TERMINAL MATCHES THE SPECIFIED OPERATING VOLTAGE OF THAT TERMINAL. REFER TO THE DATA LABEL OF THE TERMINAL FOR THE OPERATING VOLTAGE. CONNECTING THE INCORRECT POWER SOURCE TO THE TERMINAL COULD RESULT IN DAMAGE TO OR DESTRUCTION OF THE EQUIPMENT AND/OR BODILY HARM.

 CAUTION
BEFORE CONNECTING/DISCONNECTING ANY INTERNAL ELECTRONIC COMPONENTS OR INTERCONNECTING WIRING BETWEEN ELECTRONIC EQUIPMENT ALWAYS REMOVE POWER AND WAIT AT LEAST THIRTY (30) SECONDS BEFORE ANY CONNECTIONS OR DISCONNECTIONS ARE MADE. FAILURE TO OBSERVE THESE PRECAUTIONS COULD RESULT IN DAMAGE TO OR DESTRUCTION OF THE EQUIPMENT AND/OR BODILY HARM.

 CAUTION
OBSERVE PRECAUTIONS FOR HANDLING ELECTROSTATIC SENSITIVE DEVICES.

IND131 and IND331 Terminals

ServiceXXL
Tailored Services



Essential Services for Dependable Performance of Your IND131/IND331 Terminal

Congratulations on choosing the quality and precision of METTLER TOLEDO. Proper use of your new equipment according to this Manual and regular calibration and maintenance by our factory-trained service team ensures dependable and accurate operation, protecting your investment. Contact us about a ServiceXXL agreement tailored to your needs and budget. Further information is available at www.mt.com/serviceXXL.

There are several important ways to ensure you maximize the performance of your investment:

1. **Register your product:** We invite you to register your product at www.mt.com/productregistration so we can contact you about enhancements, updates and important notifications concerning your product.
2. **Contact METTLER TOLEDO for service:** The value of a measurement is proportional to its accuracy – an out of specification scale can diminish quality, reduce profits and increase liability. Timely service from METTLER TOLEDO will ensure accuracy and optimize uptime and equipment life.
 - a. **Installation, Configuration, Integration and Training:** Our service representatives are factory-trained, weighing equipment experts. We make certain that your weighing equipment is ready for production in a cost effective and timely fashion and that personnel are trained for success.
 - b. **Initial Calibration Documentation:** The installation environment and application requirements are unique for every industrial scale so performance must be tested and certified. Our calibration services and certificates document accuracy to ensure production quality and provide a quality system record of performance.
 - c. **Periodic Calibration Maintenance:** A Calibration Service Agreement provides on-going confidence in your weighing process and documentation of compliance with requirements. We offer a variety of service plans that are scheduled to meet your needs and designed to fit your budget.

Contents

Chapter 1.0	Introduction	1-1
	IND131/IND331 Overview	1-1
	Standard Features	1-1
	IND131 and IND331 Terminal Versions	1-2
	Specifications	1-3
	Use in Hazardous Areas	1-5
	Safe Disposal Requirement	1-6
	Inspection and Contents Checklist	1-6
	Model Identification	1-7
	Physical Dimensions	1-8
	Main PCB	1-10
	Scale Base	1-10
	Options	1-10
	COM2 Serial Port	1-11
	Discrete I/O	1-11
	PLC Interfaces	1-11
	SD Memory Option	1-12
	Display and Keyboard	1-13
	Display Layout	1-14
	Front Panel Keys	1-14
Chapter 2.0	Operation	2-1
	Overview	2-1
	Basic Functionality	2-1
	Zero	2-1
	Tare	2-2
	Clearing Tare	2-3
	Print	2-3
	Information Recall	2-4
	Target	2-4
	Comparators	2-6
	Calibration	2-6
	CalFREE™	2-7
	Security	2-7
	Display Operation	2-7
	Keypad Operation	2-8
	Operator Menu	2-9
	Language Selection – F Codes	2-9
	Accessing the Operator Menu	2-10
	Navigating the Operator Menu	2-10

Numerical Data Entry	2-11
Target Menu	2-13
Comparator Menu	2-14
Information Recall Menu	2-15
Calibration Menu	2-15
Setup Access	2-19
Chapter 3.0 Configuration	3-1
Setup Menu Tree	3-1
Use of Keys Within Menus	3-1
Entering Setup Mode	3-3
Security	3-3
Metrology Switch	3-4
Exiting Setup	3-4
Overview of Setup	3-4
Configuration Options	3-5
Scale – F1	3-6
Application – F2	3-14
Terminal – F3	3-18
Communication – F4	3-20
Maintenance – F5	3-29
Restoring Factory Default Settings	3-32
Chapter 4.0 Service and Maintenance	4-1
Cleaning and Maintenance	4-1
Service	4-1
Troubleshooting	4-2
Diagnostic LEDs	4-2
Problems	4-2
Error Codes and Error Messages	4-3
Internal Diagnostics	4-4
System Backup and Restore	4-7
Backup	4-7
Restore	4-9
Appendix A Default Settings	A-1
Setup Defaults	A-1
Appendix B Parameter Values	B-1
Appendix C Communications	C-1
Serial Interface Parameters	C-1
Demand Output Mode	C-2
Output Templates	C-2
Continuous Output Mode	C-3

Standard Continuous Output	C-3
Continuous – Extended Output	C-5
CTPZ	C-8
Standard Interface Command Set (SICS) Protocol	C-8
Version Number of the MT-SICS.....	C-9
Command Formats.....	C-9
Response Formats.....	C-9
Tips for the Programmer.....	C-11
Commands and Responses MT-SICS Level 0.....	C-11
Commands and Responses MT-SICS Level 1	C-16
Variable Access.....	C-19
Connection	C-19
Commands	C-19
Variable List.....	C-21

Chapter 1.0

Introduction

This chapter covers

- Overview
- Terminal Versions
- Specifications
- Use in Hazardous Areas
- Safe Disposal Requirement
- Inspection and Contents Checklist
- Model Identification
- Physical Dimensions
- Main PCB
- Scale Bases
- Options
- Display and Keyboard

The IND131 and IND331 industrial scale terminals provide a compact but flexible solution to a variety of weighing needs. Configured in a variety of enclosure types, these terminals are at home in virtually any industrial environment. They are optimized for ease of integration into existing weighing systems, and their modular construction makes for simplicity of maintenance. Innovative use of Secure Data (SD) Memory technology permits quick, simple replacement of a terminal, complete with all its calibration and configuration settings.

Both 2mv/V and 3mv/V load cells are supported without the need for any configuration change. Measurement and control applications are enhanced with an ultra-fast A/D conversion rate, patented TraxDSP™ digital filtering technology, and discrete I/O update rate of 50 Hz. The IND131 and IND331 deliver precision measurement data from grams to tons in a single cost effective package.

Whether communicating weight data to a process PLC or providing a serial output of data to a printer, the IND131 and IND331 terminals offer solutions for a wide range of applications.

IND131/IND331 Overview

Standard Features

- Modular design, multiple mounting methods
- Supports one analog load cell platform (up to four 350 ohm load cells)
- Ability to position the IND331 panel-mount display remotely from the DIN terminal module
- Organic LED (OLED) displays for crisp readability in all light conditions
- One serial port for asynchronous, bidirectional communication and print output
- Powered by either 85–264 V AC or 24 V DC (selected by model)
- Support for the following option boards:
 - COM2 and Discrete I/O interface

- Choice of one PLC interface:
 - 4-20mA Analog Output
 - Ethernet/IP
 - PROFIBUS® DP
 - DeviceNet™
 - Allen Bradley RIO®
 - Modbus TCP
- Front panel key access to basic weighing functions – zero, tare, clear and print
- Latching target control to provide one- or two-speed feeding control with the press of a start button
- Rate calculation used for comparator source or communicated to a PLC
- Comparators - simple coincidence setpoints for comparison of weight or rate with absolute target values or ranges
- Selectable unit of measure including grams, kilograms, pounds, tons
- Backup and restore of configuration and calibration settings, using SD memory device or InSite™ PC tool
- TraxEMT™ performance monitoring and recording
- CalFREE™ calibration without test weights
- Scale calibration via Ethernet/IP, PROFIBUS, DeviceNet, A-B RIO and Modbus TCP interfaces.

IND131 and IND331 Terminal Versions

The terminals are available in the following versions:

- IND131 DIN rail mount, AC power
- IND131 DIN rail mount, 24 VDC power
- IND331 Panel-mount, AC power
- IND331 Panel-mount, 24 VDC power
- IND331 Harsh, AC power
- IND331 Harsh, 24 VDC power
- IND131 Junction Box, AC power
- IND131 Junction Box, 24 VDC power

Specifications

The IND131 and IND331 terminals conform to the specifications listed in **Error!**
Reference source not found..

Table 1-1: Terminal Specifications

IND131 and IND331 Specifications	
Enclosure Type	IND131 DIN rail-mount: plastic housing with operator interface
	IND331 Panel-mount: Stainless steel front panel with operator interface. Plastic rear chassis that can be mounted to the display or remotely DIN rail mounted.
	IND331 Harsh: Stainless steel desk top or wall mount enclosure including operator interface.
	IND131 J-Box: Stainless steel enclosure including internal board for summing four load cells.
Dimensions (w × h × d)	IND131 DIN module: 68 mm × 138 mm × 111 mm (2.7 in. × 5.4 in. × 4.4 in.)
	IND331 Panel-mount: Front panel: 168 mm × 68 mm × 12 mm (6.6 in. × 2.7 in. × 0.5 in.) Rear chassis: 156 mm x 68 mm x 111 mm (6.1 in. x 2.7 in. x 4.4 in.)
	IND331 Harsh: 220 mm x 131 mm x 177 mm (8.7 in. x 5.2 in. x 7.0 in.)
	IND131 J-Box: 251 mm x 261 mm x 123 mm (9.9 in. x 10.3 in. x 4.8 in.)
Shipping Weight	IND131 DIN: 1 kg (2.2 lb) IND331 Panel: 1.5 kg (3.3 lb) IND331 Harsh: 3 kg (6.5 lb) IND131 J-Box: 4.5 kg (10.1 lb)
Environmental Protection	IND131 DIN: IP20, Type 1 IND131 J-Box: IP69K, Type 4x and 12
	IND331 Panel: IP65, Type 4x and 12 IND331 Harsh: IP66, Type 4x and 12
Operating Environment	The terminal (all enclosure types) can be operated at temperatures ranging from –10° to 40° C (14° to 104° F) at 10% to 95% relative humidity, non-condensing.

IND131 and IND331 Specifications	
Hazardous Areas	The IND131/IND331 terminal cannot be operated in areas classified as Hazardous because of combustible or explosive atmospheres in those areas. Contact an authorized METTLER TOLEDO representative for information about hazardous area applications.
Power	AC version: Operates at 85–264 VAC, 49–61 Hz
	DC version: Operates from 18 to 36 VDC
	All versions provide a terminal strip for power connections.
	AC versions of the harsh environment and junction box models include a power cord configured for the country of use.
Power Consumption	Refer to Error! Reference source not found. and Error! Reference source not found.
Display	Green OLED including weight display, weight units, gross/net indication and graphic symbols for motion and center of zero. Also used for programming. Update rate of 10 updates per second. IND131: 4 mm high weight display IND331: 12 mm high weight display
Weight Display	Maximum displayed resolution of 100,000 divisions.
Scale Types	Analog load cells
Number of Cells	From one to four 350-ohm load cells (2 or 3 mv/V)
Number of Scales	One
Analog/Digital Update Rates	Internal analog: 366 Hz Target Comparison: 50 Hz; PLC Interface: 20 Hz
Load Cell Excitation Voltage	5 V DC
Minimum Sensitivity	0.1 microvolts
Keypad	4 keys; polyester overlay (PET) with polycarbonate display lens
Communications	Serial Interfaces Standard: One serial port (COM1) RS-232, 300 to 115,200 baud Optional Serial Port: (COM2) RS-232/485, 300 to 115,200 baud Protocol Serial Inputs: ASCII commands for CTPZ (Clear, Tare, Print, Zero), SICS (most level 0 and level 1 commands) Serial Outputs: Continuous, Extended continuous or Demand (limited formats)

IND131 and IND331 Specifications	
Approvals	<p>Weights and Measures USA: NTEP Class III/IIIL – 10,000 d Canada: Class III - 10,000d; Class IIIHD - 20,000d (both pending) Europe: OIML; Class III, 6000 e; (pending)</p> <p>Product Safety UL, cUL, CE</p>

Table 1-2: IND131, IND331 Power Consumption (AC Source)



Input Voltage	IND131		IND331	
	I (mA)	P (W)	I (mA)	P (W)
85V/50 Hz	73	3.3	79	3.5
110 V/50 Hz	58	3.3	63	3.5
240 V/50 Hz	28	3.3	30	3.6
264 V/50 Hz	27	3.4	28	3.6
85 V/60 Hz	70	3.3	75	3.5
110 V/60 Hz	56	3.3	60	3.5
240 V/60 Hz	27	3.4	30	3.6
264 V/60 Hz	27	3.5	28	3.8

Table 1-3: IND131, IND331 Power Consumption (DC Source)

Input Voltage	IND131		IND331	
	I (mA)	P (W)	I (mA)	P (W)
18VDC (min)	158	2.84	170	3.06
24 VDC	120	2.88	130	3.12
36 VDC (max)	84	3.02	90	3.24

Values shown are with internal COM2/DIO option and Analog Output option installed and load cell input loaded with 4 x 350Ω load cells.

Use in Hazardous Areas

	 WARNING!
	<p>DO NOT USE THE IND131 OR IND331 TERMINALS IN AREAS CLASSIFIED AS HAZARDOUS BECAUSE OF COMBUSTIBLE OR EXPLOSIVE ATMOSPHERES. CONTACT AN AUTHORIZED METTLER TOLEDO REPRESENTATIVE FOR INFORMATION ABOUT HAZARDOUS AREA APPLICATIONS.</p>

Safe Disposal Requirement

In conformance with the European Directive 2002/96/EC on Waste Electrical and Electronic Equipment (WEEE) this device may not be disposed of in domestic waste. This also applies to countries outside the EU, per their specific requirements.



Please dispose of this product in accordance with local regulations at the collecting point specified for electrical and electronic equipment.

If you have any questions, please contact the responsible authority or the distributor from which you purchased this device.

Should this device be passed on to other parties (for private or professional use), the content of this regulation must also be related.

Thank you for your contribution to environmental protection.

Inspection and Contents Checklist

Verify the contents and inspect the package immediately upon delivery. If the shipping container is damaged, check for internal damage and file a freight claim with the carrier if necessary. If the container is not damaged, remove the terminal from its protective package, noting how it was packed, and inspect each component for damage.

If shipping the terminal is required, it is best to use the original shipping container. The terminal must be packed correctly to ensure its safe transportation.

The package should include:

- IND131 or IND331 Terminal
- Note: Panel-mount model includes DIN housing, panel display, mounting brackets and barrel nuts.
- Installation manual
- Documentation CD (includes all manuals)
- Bag of miscellaneous parts, depending on terminal configuration

Model Identification

The IND131/IND331 model number, factory number and serial number are located on the data plate of the terminal. Refer to **Error! Reference source not found.** to verify the configuration of the IND131/IND331 terminal.

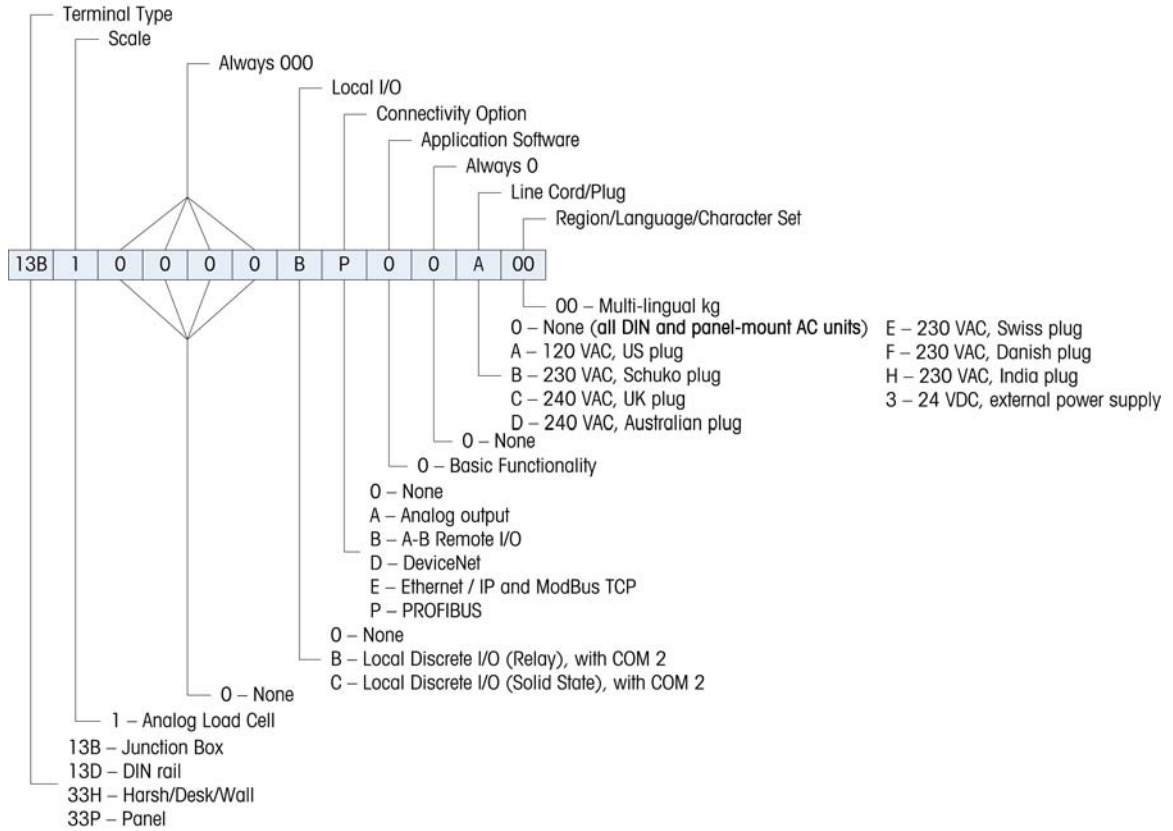

Figure 1-1: IND131/IND331 Model Identification Numbers

Physical Dimensions

The physical dimensions of each of the IND131 and IND331 enclosures are shown in the following four Figures in mm and [inches].

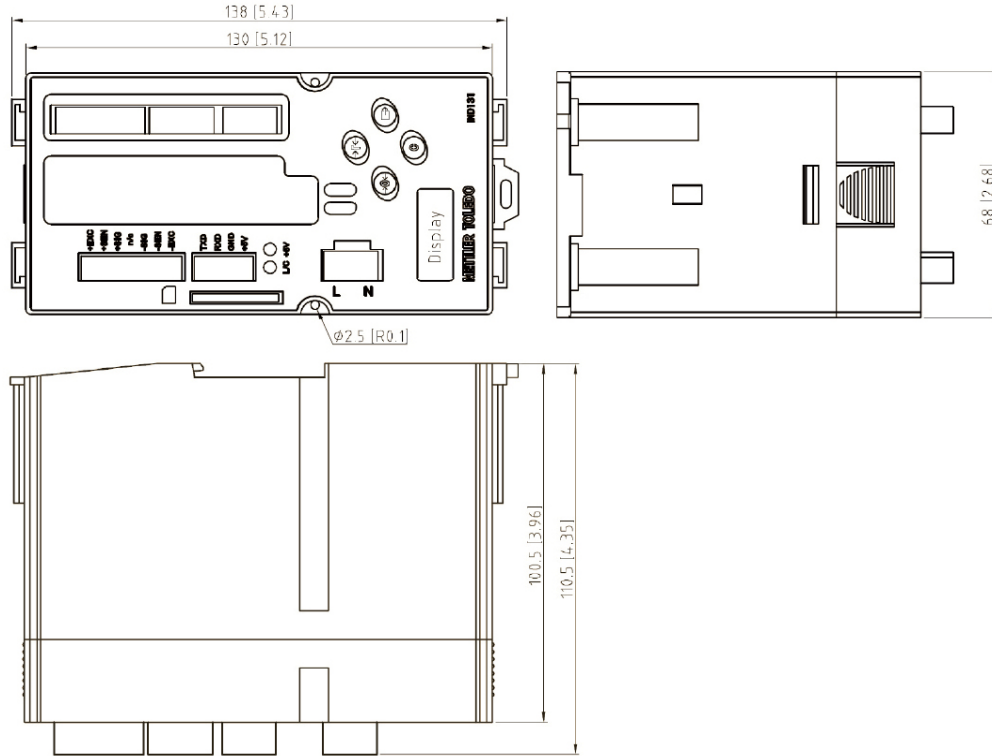

Figure 1-2: IND131 DIN Rail Mount Enclosure Dimensions

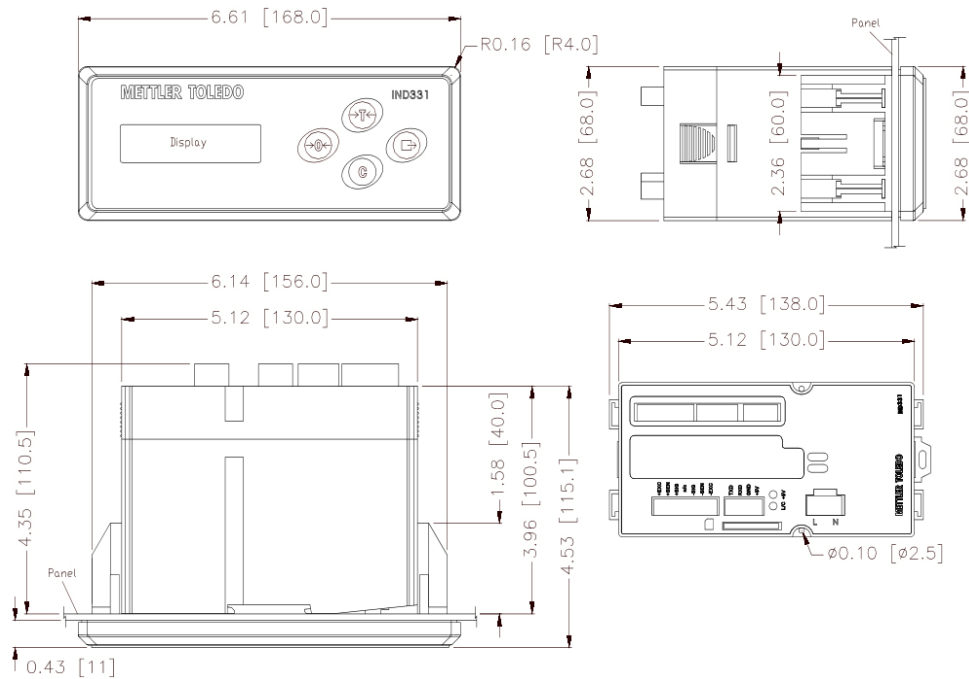

Figure 1-3: IND331 Panel Mount Enclosure Dimensions

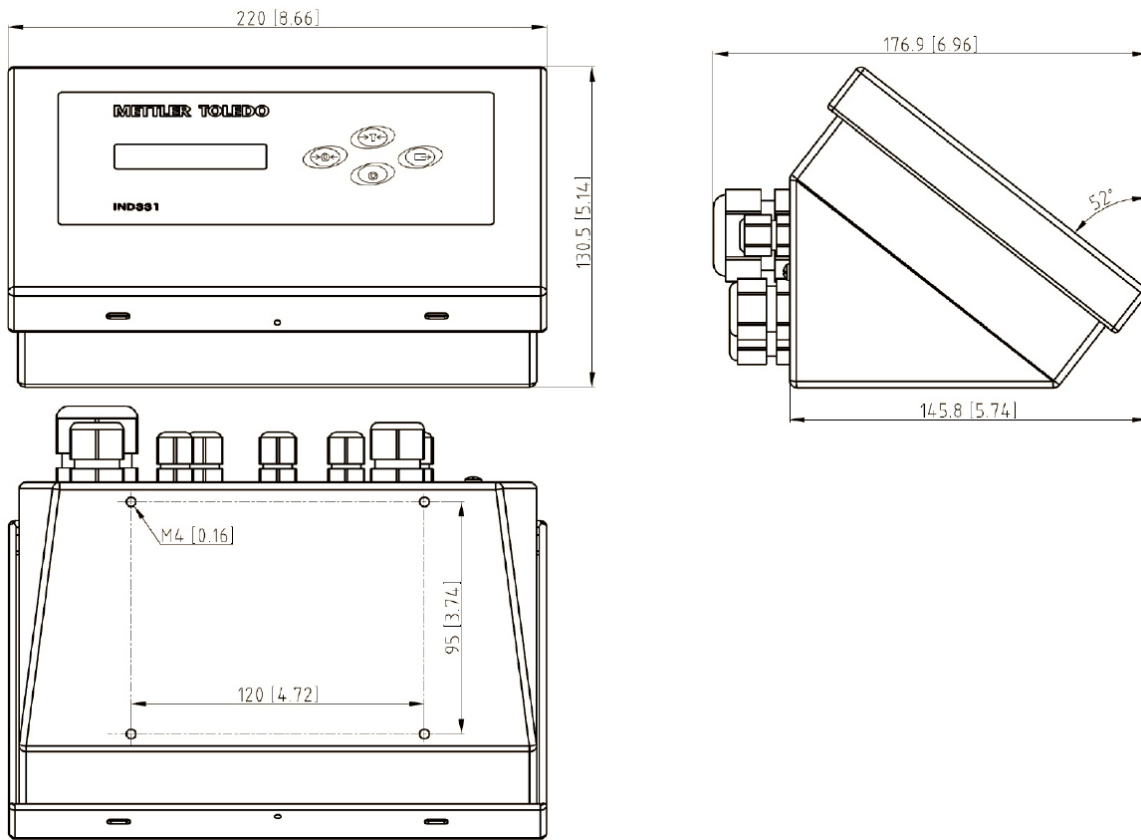

Figure 1-4: IND331 Harsh Enclosure Dimensions

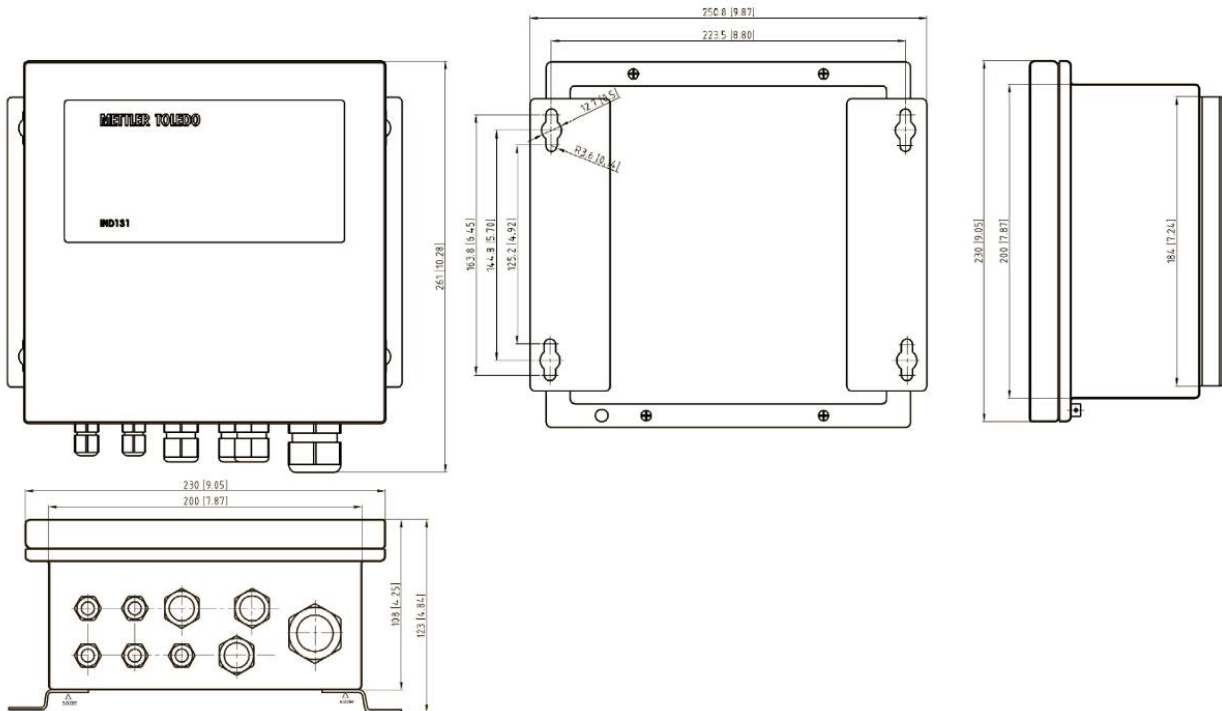

Figure 1-5: IND131 Junction Box Enclosure Dimensions

Error! Reference source not found. shows the measurements for the drilled holes required to mount the Panel Mount enclosure.

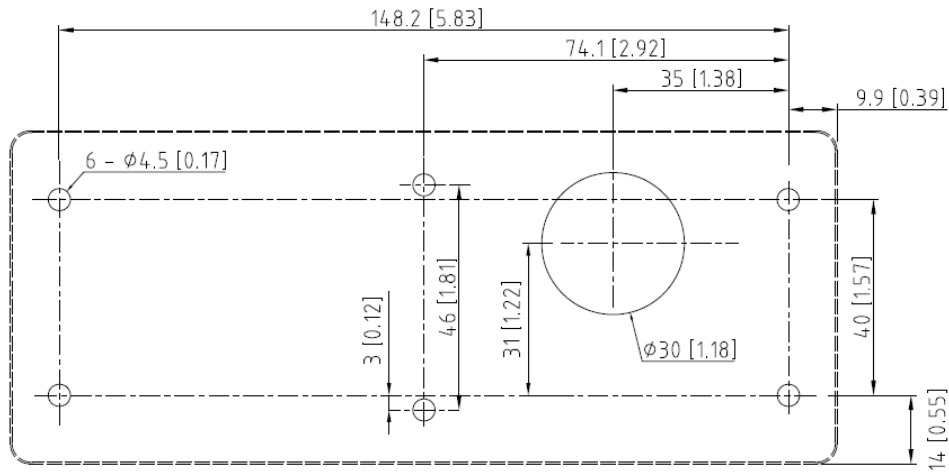

Figure 1-6: IND331 Panel Mount Drill Template

Main PCB

The IND131/IND331 terminal's main printed circuit board (PCB) provides the analog load cell scale interface, as well as the COM1 RS-232 serial port.

The main board also contains the power input connection (for either AC or DC supply, depending on the model), display interfaces (one each for the larger IND331 and smaller IND131 displays), 6 position DIP switch and bus connectors for the PLC and COM2/DIO option boards.

Two LEDs are provided to indicate the operational status of the terminal and a memory card socket is mounted to the under-side of the PCB to support the optional SD memory.

Scale Base

The IND131/IND331 terminals support analog scale bases and provide 5 volts of excitation to drive up to four 350-ohm analog load cells.

A six wire load cell connection is provided with sense lines to help maintain accuracy as the load cell cable resistance changes with temperature variations.

Options

The following options are available for the IND131/IND331:

- COM2/DIO (relay output)
 - One RS-232/485 serial COM port

Internal, discrete I/O (2 inputs and 4 outputs)

- Inputs are optically isolated solid state and switch selectable as either active or passive
- Output relays provide one normally open contact per relay

- COM2/DIO (solid state output)

One RS-232/485 serial COM port

Internal, discrete I/O (2 inputs and 4 outputs)

- Inputs are optically isolated solid state and switch selectable as either active or passive
- Outputs are solid state open collector

- Programmable Logic Control (PLC) interfaces, including:

4-20mA Analog Output	A-B RIO	DeviceNet
PROFIBUS DP	Ethernet/IP	ModbusTCP

COM2 Serial Port

This optional port provides RS-232 and RS-485 communication at rates from 300 to 115.2k baud. The port is bidirectional and can be configured for various functions such as demand output, continuous output, SICS host communications and ASCII command input (C, T, P, Z).

Discrete I/O

The discrete I/O interface option is available with dry-contact or solid state relay outputs. The relay contacts will switch up to 30 volts DC or 250 volts AC at 1A. The solid state outputs will switch up to 30 volts DC at 350mA maximum.

The inputs are switch selectable as either active (for simple pushbutton control) or passive (for connection to PLCs or other devices that supply their own power for the inputs).

PLC Interfaces

IND131 and IND331 interface options include 4-20mA Analog Output, A-B RIO, DeviceNet, PROFIBUS DP, Ethernet/IP, ControlNet and Modbus TCP. Additional details about each of these interfaces can be found in the IND131/IND331 PLC Interface Manual, provided on the documentation CD.

Analog Output

The Analog Output option provides a 16-bit 4-20mA analog signal corresponding to the gross or net weight or the rate. The analog signal is isolated and requires that the connected device have an internal resistance of 500 ohms or greater.

Two solid state error outputs are provided to indicate out of range and error conditions.

A-B RIO

The A-B RIO option enables data exchange by bi-directional communications using the Discrete Data Transfer mode. The IND131/IND331 terminals provide new information for the PLC approximately 20 times per second. This communication is a high-speed, real-time message interface between the terminal and the PLC for process control. Division, integer, and floating point values are supported. The A-B RIO interface does not support Block Transfer mode.

DeviceNet

DeviceNet is an RS-485 based network utilizing CAN chip technology. This network was created for bit and byte-level devices. The network can be configured to run up to 500Kbits per second depending on cabling and distances. Messages are limited to 8 unfragmented bytes. The network can include up to 64 nodes including the master, commonly called the scanner.

PROFIBUS DP

The terminal communicates to a PROFIBUS-DP master according to DIN 19 245. PROFIBUS is an open, RS-485 digital communication system with a wide range of applications, particularly in the fields of factory and process automation. PROFIBUS is designed for use in fast, time-critical applications. Additional specifications can be found in PROFIBUS International documents. A maximum of 126 devices (masters or slaves) can be connected to a bus.

EtherNet/IP and Modbus TCP

The IND131/IND331 terminals support communications of the EtherNet/IP or Modbus TCP interface options, using a common interface.

EtherNet / IP utilizes commercial, off-the-shelf EtherNet hardware (for example, switches and routers) and is fully compatible with the Ethernet TCP/IP protocol suite. It uses the proven Control and Information Protocol (CIP) to provide control, configuration and data collection capability.

Modbus TCP protocol is a messaging structure that is used to establish master-slave/client-server communication between intelligent devices. The protocol can be used in multiple master-slave applications to monitor and program devices; to communicate between intelligent devices and sensors and instruments; and to monitor field devices using PCs and HMIs.

SD Memory Option

An optional SD Memory card provides a medium on which to extract and save the configuration and calibration settings of the terminal. These can then be restored to the terminal or loaded to a different terminal. This feature can be used to clone the

setup of one terminal then transfer it to other units, which minimizes the chance of error in setting up a new configuration.

Display and Keyboard

The IND131 terminal has an Organic LED (OLED), 128 × 32 graphic type display with 4mm high digits. The IND131 DIN model is shown in **Error! Reference source not found.**. The same module is used internally in the IND131 Junction Box model.



Figure 1-7: IND131 Front Panel Layout

The panel-mount and harsh models of the IND331 (**Error! Reference source not found.**) include a 128 x 22 pixel graphic OLED display with 12mm high digits.



Figure 1-8: IND331 Front Panel Layout

Display Layout

During normal operation, the IND131 and IND331 displays show the Gross or Net weight, together with the weight units and the weight legend. Graphic symbols are used to indicate center of zero and motion. For display operation during setup, refer to Chapter 3.0, **Configuration**.

Front Panel Keys

Four dedicated scale function keys are located to the right of the display. These provide the interface to zero or tare the scale, to clear a tare, and to initiate a print. The same keys are used to enter the setup menu, to navigate and select setup elements, and to enter values in setup as described in Chapter 3.0 **User's Guide, Configuration**.

Operation

This chapter covers

- Overview
- Basic Functionality
- Security
- Display Operation
- Keypad Operation
- Operator Menu

Overview

This chapter provides information about the basic functionality of the IND131 and IND331 terminals including display operation, keypad functions and menu navigation.

Operation of the terminal depends on enabled functions and parameters that are configured in setup as described in Chapter 3.0, **Configuration**. Navigation and basic functionality are covered in the following sections.

Basic Functionality

This section provides information about the IND131/IND331's basic functionality. Functions addressed in this section include:

- Zero
- Tare
- Clearing Tare
- Print
- Information Recall
- Target
- Comparators
- Calibration
- CalFREE

Refer to Chapter 3.0, **Configuration**, for further information about programming all the functionality described in this section.

Zero

The Zero function is used to set or reset the initial zero reference point of the terminal. There are two types of zero setting modes:

- Automatic Zero Maintenance
- Pushbutton Zero

Automatic Zero Maintenance

Automatic Zero Maintenance (AZM) enables the IND131/IND331 to compensate for the build up of small amounts of weight and track itself back to the center of zero. Within the AZM operating range (selectable from 0.5, 1, 3 or 10 divisions), when the terminal is in a no motion condition, it makes small adjustments to the current zero reading to drive the weight reading toward the true center-of-zero. When the weight is outside of the programmed AZM range, this feature is not functional.

Pushbutton Zero

The pushbutton (semi-automatic) zero function can be accomplished by pressing the ZERO →0← scale function key, by programming a discrete input, by using a PLC command, or by issuing a serial command.

The range for all types of semi-automatic zero is selectable (Disabled, 2% or 20%) plus or minus from the calibrated zero point.

Remote initiation of the semi-automatic Zero command is possible via a discrete input, an ASCII 'Z' command sent serially (CPTZ and SICS interface modes), or a command initiated by the PLC interface.

Tare

Tare is the weight of an empty container. A tare value subtracts from the gross weight measurement, providing the computation of the net weight (material without the container). The tare function can also be used to track the net amount of material being added to or removed from a vessel or container. In this second case, the weight of the material in the container is included with the tare weight of the container and the display then reflects the net amount being added to or removed from the vessel.

Tare operations in the IND131/IND331 includes:

- Pushbutton Tare
- Net Sign Correction

Pushbutton Tare

Pushbutton tare can be configured in setup as enabled or disabled. When disabled, the TARE scale function key →T← cannot be used to obtain a tare.

If enabled, pressing the pushbutton TARE scale function key →T← initiates a semi-automatic tare. The IND131/IND331 will attempt to perform a tare process. If the process is successful, the display changes to a zero net weight indication and the previous weight on the scale is stored as the tare value. The net mode will be indicated on the display.

Several conditions could inhibit the pushbutton tare function:

Motion – Pushbutton tare cannot be taken when the scale is in motion. If motion is detected when a pushbutton tare command is received, the IND131/IND331 will wait up to three seconds for a no-motion condition. If a stable (no motion) weight condition occurs before the three seconds expire, the pushbutton tare command is executed.

If there is still motion at the end of three seconds, the command is aborted.

Pushbutton Tare Disabled – If pushbutton tare is configured as disabled, the TARE scale function key will not initiate a semi-automatic tare.

Negative Gross Weight – Any pushbutton tare attempted when the gross weight is at or below zero is ignored. Ensure that the gross weight is above zero.

Net Sign Correction

Net sign correction enables the terminal to be used for both shipping (inbound empty) and receiving (inbound loaded) operations. Net sign correction can be either disabled or enabled on the IND131/IND331.

If net sign correction is disabled in setup, the stored weight value in the tare register is assumed to be a tare regardless of the gross weight present on the scale at the time of the final transaction. Net values can therefore be negative if the weight on the scale is less than the tare value.

If net sign correction is enabled, the terminal will switch the gross weight and tare weight fields when necessary, so that the larger weight is the gross weight, the smaller weight is the tare weight, with the difference always a positive net weight. Net sign correction affects the display and printed data.

An example of weight values with and without net sign correction is shown in Table 2-1. In this example, the tare register value is 53 kg and the live weight on the scale is 16 kg.

Table 2-1: Weight Values With and Without Net Sign Correction

Printed and Displayed	Net Sign Correction	
	Disabled	Enabled
Gross	16 kg	53 kg
Tare	53 kg	16 kg
Net	-37 kg	37 kg

Clearing Tare

Manually clear tare values by pressing the CLEAR key **C** on the keypad when the IND131/IND331 is in the net mode and has completed the weighing operation. Motion on the scale will not impact a manual clear. The weight display will return to the gross weight value.

Print

The print function (demand print) can be initiated by pressing the PRINT  function key on the main keyboard or by automatic print settings. Demand printing of data may also be initiated as part of a particular sequence of operation or special application software.

Information Recall

A limited number of data fields are made available for easy recall on the terminal display. These fields include data such as model, serial number, identification fields, hardware and software configuration, a service contact phone number and whether the terminal has been set up as approved for legal for trade operation.

All this data is accessible under the Information Recall icon  in the operator menu.

Target

Target comparison is used to compare either the gross or net weight on the scale to a predetermined target value. This feature is typically used in automatic processes. As an example, an automatic filling system using target comparison could provide a Start signal to the terminal and the IND131 or IND331 terminal could control the feeder system to fill a container to a desired target then turn the outputs off. The target comparison rate is 50 comparisons per second.

If the target comparison will be used to control the flow of material, the application can be classified as a Material Transfer application. These types of applications are usually automated but can also be manual. A single or two-speed feeding system is used to either add weight to or remove weight from the scale. The terminal monitors the change in weight and compares it to a previously entered target and other control parameters.

Target Control

Latching outputs must be enabled for the terminal to provide the automated control. For a latched output, only a Start discrete input signal is needed to begin the target comparison process. No other control is required. The comparison runs to completion then the latch sets the outputs FALSE until a Start signal is received the next time.

For simple applications, the target output can be programmed as a coincidence signal and the target control can be handled by external logic or a PLC.

Target Terms

The following definitions explain some terms used in Material Transfer applications:

Abort

While a latched target comparison process is in process, it can be totally stopped by an Abort signal. This signal is not used in a coincidence type of target.

Coincidence Outputs

A coincidence output is always active and does not require a start or stop signal. If the weight on the scale is below the target minus the spill value, the outputs are "on". If the weight is above the target minus the spill value, the outputs are "off". This type of output typically requires external logic to provide the required control for feeding systems.

Concurrent Outputs	This describes the operation of the Feed output in a 2-speed feeding system. If the feeder type is programmed as concurrent, both the Feed output and the Fast Feed output turn on when the Start is triggered. The Fast Feed continues to operate until the weight reaches the Target minus the Fine Feed value and the Feed continues to operate until the weight reaches the Target minus the Spill value. Both the Fast Feed output and the Feed output are active concurrently at the beginning of a feed cycle. It is the opposite of independent outputs.
Fast Feed Output	This refers to the physical output connection that is used for the faster feed in a 2-speed feeding system. This output is not used in a single speed feeding system.
Feed Output	This refers to the physical output connection that is used for the slower feed in a 2-speed feeding system or the only feed output in a single speed feeding system.
Fine Feed	The value entered for the amount of material that will be fed in the slower rate of feed in a 2-speed feeding system. This value and the spill value are subtracted from the target to determine the point that the fast feed output turns off.
Independent Outputs	This describes the operation of the feed output in a 2-speed feeding system. If the feeder type is programmed as independent, the Feed output does not turn on until the Fast Feed output turns off. Only one feeder speed is active at a time. It is the opposite of concurrent outputs.
Latched Outputs	When the target is selected as Latched, the outputs turn off at the target weight minus the spill value and remain off (regardless of additional weight changes) until a "start" signal is received. These types of outputs do not usually require external logic to perform standard weigh-in or weigh-out sequences.
Spill	The amount of material that will be added (on a weigh-in) or removed (on a weigh-out) from the scale after the final feed is turned off. In a weigh-in process, this is the material in suspension that will still fall onto the scale when the feed is turned off. This value is subtracted from the target value to determine when the feed output turns off.
Start	When using latched targets, the default condition is with the latch set or in the "off" condition. To turn any outputs "on", a start signal is required. This is done by a discrete input programmed as Target Start/Resume.
Target	The target is the weight value that is the end goal of the material transfer process. If a container should be filled with 10 kg of material, the target value is 10 kg.
Tolerance	The weight range above and below the target value that will be acceptable as an "in tolerance" target comparison. The tolerance can either be entered as a weight deviation from the target or a percentage deviation from the target depending upon setup.

Comparators

Comparators are simple targets, three of which can be configured in setup. They are controlled either by coincidence or by comparison with a range. Each Comparator's limit/s may be modified by accessing the operator menu if enabled in setup. To use a Comparator, it must be assigned to a discrete output.

When the Active value is $<$, \leq , $=$, \geq or $>$, the selected source is compared to a target weight. When the Active value is within ($>_ _<$) or outside ($_< _>$) a range, the selected source is compared to a range defined by the Limit and High Limit values.

Target Value Comparators

In this case, the output will be triggered depending on the Active setting. For example, if the Active operator is \leq (less than or equal to) and the Limit is 1000 kg, the output be ON when the weight is below 1000 kg and will turn OFF when the measured value reaches 1000 kg.

Range Comparators

In the case of a Range mode Comparator, the Limit value sets the lower of the two rates that define the range, within or outside (depending on the operator) which the output is active. For example, if the Active operator for a rate sourced comparator is Within ($>_ _<$), the Limit is 3.0 kg/sec and the High Limit is 8 kg/sec, the output will be active provided the rate remains between 3 and 8 kg/sec. If the rate falls below 3 or exceeds 8 kg/sec, the output will turn OFF.

- ▶ Note that the Rate value configured in setup at Scale $>$ Rate permits weight and time units to be defined, together with the period between measurements and the number of measurements averaged to generate the output value.
- ▶ If the weight information in the terminal becomes invalid, the Rate display will show 0.000.

A Range Comparator can also use displayed or gross weight as its source. As an example, set **Gross** weight is the source, the Active operator as $_< _>$ (outside), and the **Limit** and **High Limit** values at 200 kg and 1500 kg respectively. The output will turn "ON" when the gross weight is below 200 kg or above 1500kg. The output will be "OFF" when the weight is between 200 kg and 1500 kg. A typical application might be to indicate if the weight in a large vessel falls below a minimum value (200 kg) or exceeds a maximum value (1500 kg).

Calibration

Calibration is the process of adjusting the display of the terminal so that when the scale is empty, the display shows zero gross weight and, with a specific amount of weight on the scale, shows an accurate weight value. The IND131 and IND331 terminals provide the traditional zero calibration and three different types of span calibration.

- Traditional span calibration - using test weights
- Step calibration - using a build-up or substitution method of calibration (for large vessels where only a portion of the required test weights can be placed on the scale)
- CalFREE calibration – once certain load cell criteria have been entered manually, the terminal will automatically calculate the span; no test weights are required

When calibration access is enabled for the operator menu, zero and span procedures for the weighing system can easily be performed without entering setup. This is useful to provide quick access to the calibration process without having to step through the complete setup mode.

To provide additional protection from unintentional modifications to the calibration values, the calibration icon can be removed from the operator menu. In this case, calibration can only be accessed by entering setup mode.

CaIFREE™

The IND131 and IND331 terminals provide a method to calibrate a scale without using test weights. This is based on manual entry of capacity and performance data from the load cell or load cell platform. This method of calibration can be used for initial check-out and testing of systems or when a large structure is used as the weighing vessel and it is not possible to apply test weights to the structure. METTLER TOLEDO highly recommends that test weights be used whenever possible as this provides the most accurate method of calibration.

Security

Access to the configuration/setup mode of the terminal can be password protected if enabled in setup. A single password of up to 6 digits can be programmed. If enabled, the password will be prompted when the setup mode is accessed. The correct password must be entered in order to access the setup mode.

The operator level menu which provides access to target and comparator data entry is not protected by this password so operators can easily change operational parameters but configuration data can be protected.

Display Operation

When in the weighing mode, the display is used for indicating the weight value and other types of information related to the weight. The other information provided includes:

- Weight unit (lb, kg, g, ton, t)
- Motion / no-motion condition
- Center of zero

- Gross or net mode

An example of the display format for the weighing mode data is shown in Figure 2-1.



Figure 2-1: Display in Weighing Mode

When accessing the operator menu or setup mode, the display is also used to display icons, parameters and settings. This operation is explained in the following sections and a display of the target value entry is shown in Figure 2-2



Figure 2-2: Display in Operator Entry Mode, Target Icon Displayed

Keypad Operation

The front panel scale function keys are used to operate the IND131/IND331 and also configure the terminal as described later in this chapter.

Figure 2-3 shows the four scale function keys on the front panel of the IND331. The IND131 is equipped with smaller versions of the same keys. Table 2-2 explains the function of each of the four keys during normal operation.



Figure 2-3: IND131/IND331 Scale Function Keys

Table 2-2: Keypad Functions – Normal Operation

	ZERO When the scale platform or weighbridge is empty, the terminal should indicate zero. The gross zero reference is recorded during calibration. Press the ZERO scale function key to capture a new gross zero reference point if pushbutton zero is enabled in configuration and the weight is within the zero range. This key also provides access to the operator menu and setup mode when pressed for 3 seconds or more.
	TARE Tare is the weight of an empty container. The tare weight is can be subtracted from the gross weight of a package to determine the net weight of the contents of a container. Press the TARE key when an empty container is on the scale. The terminal then displays a zero net weight. As the container is loaded, the terminal then displays the net weight of the contents. Pushbutton tare must be enabled to use the Tare key.
	CLEAR When in the net weight mode, if the Clear key is pressed, the current tare value will be cleared which will cause the weight display to revert to the gross weight value. The Clear key operates regardless of motion on the scale. Note that once the tare value has been cleared, it cannot be recalled. The complete tare process as described above must be performed.
	PRINT Press the PRINT scale function key to initiate a demand output of the programmed print data. A demand output connection must be configured for the selected serial port.

The Zero, Tare and Print functions will not operate when there is motion on the scale. If one of these keys is pressed while the scale is in motion, the command will be retained for 3 seconds while the terminal waits for no-motion. If a no-motion condition is not detected within the 3 seconds, the request is cancelled and discarded.

Operator Menu

There are a few functions that operators typically perform which are available in a top-level menu system in the IND131 and IND331 terminals. These include target value entry, comparator value entry, data recall and calibration. An explanation of how to access these functions follows.





Language Selection – F Codes

Depending on the terminal's language setup (at Terminal | Region | Menu Language), parameter labels in the operator menu will appear as words ("Target") or as an F-code ("F2.2.1"). For clarity, **both** are shown in all of the flow charts in this chapter.

Accessing the Operator Menu

To access the operator menu, the PRINT key must be pressed and held for approximately 3 seconds. At the end of the 3 seconds, the display will change from showing the normal weigh display to showing an icon. Depending upon programming in the terminal, the icon shown will be one of the ones shown in Table 2-3 below. The Target, Comparator and Calibration icons can be added or removed from the operator menu by programming in the setup mode.

Table 2-3: Operator Menu Icons

	Target	Access to all target values including the target, tolerances, fine feed and spill values.
	Comparators	Access to the limit value (and high limit value if the comparator is programmed as a range) for all comparators.
	Information Recall	Recall mode for all terminal information fields.
	Calibration	Quick access to zero and span adjustment (in non-approved mode only).
	Setup	Access to all setup parameters for the terminal.

Navigating the Operator Menu

When navigating through the operator menu, the function of the keys on the keypad change. The keys now work as navigation keys to navigate to the correct entry group. Figure 2-4 shows the function of the keys when viewing the operator menu.

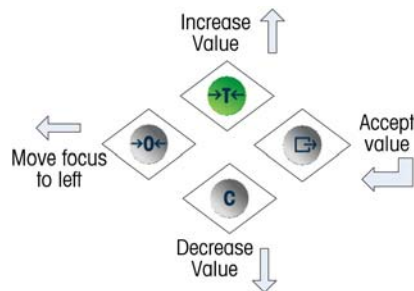

Figure 2-4: Key Functions When Viewing the Operator Menu

The operator menu is accessed by pressing and holding the PRINT key for 3 seconds. Then, using the four keys on the keypad, an operator can easily navigate to and view and/or change an item in the Operator Menu. An overview of the operator menu is shown in Figure 2-5.

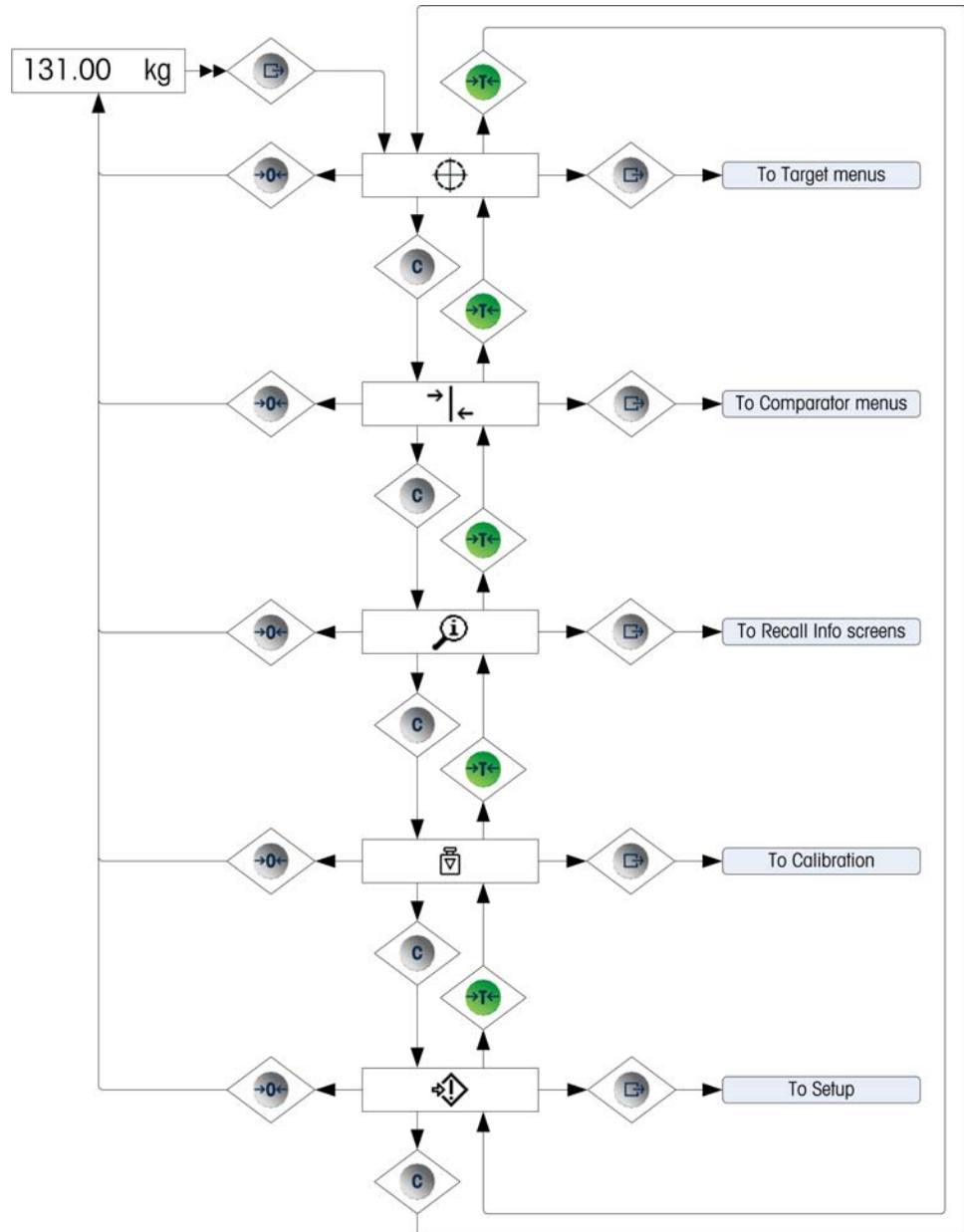

Figure 2-5: Operator Menu Overview

Numerical Data Entry

An operator may be required to change a value in the operator menu such as a target value for instance. The four keys on the keypad are also used to make selections and for data entry.

After selecting one of the operator menu icons (by pressing PRINT), a list of parameters associated with that function will be shown – two items shown on the

display at a time. One of the items will be in "focus" indicated by reverse video. Refer to Figure 2-6 where the Target line is shown in focus.



Figure 2-6: Menu Item in Focus

The item in focus is the active item. The focus is moved by pressing the TARE (up) key and CLEAR (down) key. When the parameter to be changed is in focus, press the PRINT (enter) key and the value for that parameter will be shown. Refer to Figure 2-7 which shows the data entry for the target value.



Figure 2-7: Target Entry Screen, Value in Focus

Once a parameter is accessed, as in Figure 2-7, data entry is possible. To indicate this, the far right digit of the value on the bottom line of the display will be flashing. The flashing digit indicates the position of the currently editable value. This digit can be increased by pressing TARE (up) or decreased by pressing CLEAR (down) until the desired digit is displayed. To move to the next position to the left, press the ZERO key. The ZERO, TARE and CLEAR keys are used until the desired value is displayed then the PRINT key is used to accept and save the new data.

Figure 2-8 details the method for entering numerical values in a flow chart form. Note that, whether or not the setting is altered, the PRINT key will confirm the currently displayed value and return the view to the next higher menu. In the flow charts that follow, values that can be modified are indicated by a blue star –

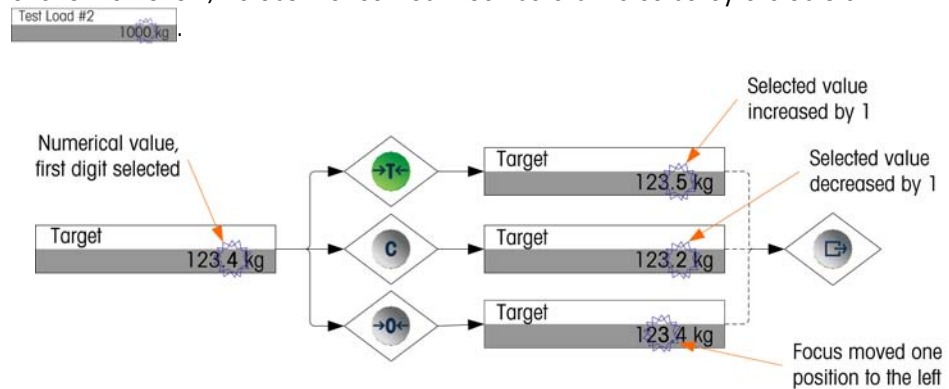



Figure 2-8: Setting Numerical Values

When the value has been entered and the display shows a list of items again, the ZERO key can be pressed to exit to the next higher level of the menu. Pressing the ZERO multiple times will exit the operator menu.

Target Menu

If the Target menu is enabled for the operator, Target values can be modified without entering setup. Once the Target icon  appears (as in Figure 2-2), press the PRINT key to access the displays to set parameters associated with the target. Refer to the Numerical Data Entry section on page 2-11 for the method used to modify numerical values. Depending on the parameters configured in Setup at Application I Target Setup, the tolerance values will either be in absolute weight values or percentages of the target.

Details of the target menu are shown in Figure 2-9. The function of each of these parameters is described in Chapter 3.0, **Configuration**. Note that both the text and F-code labels for each field are shown.

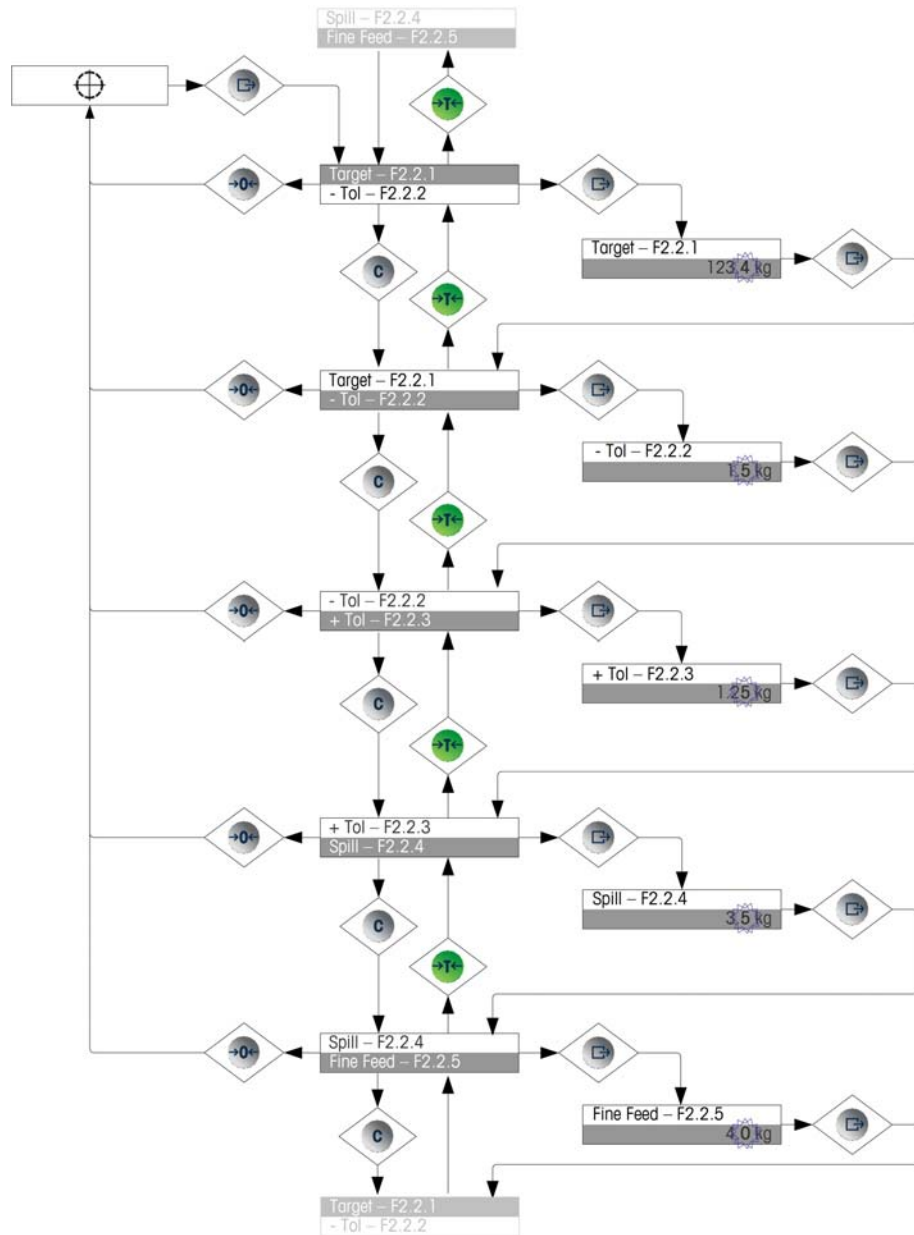



Figure 2-9: Target Setup Screens

Comparator Menu

If the Comparator feature is enabled in the operator menu, Comparator parameters can be modified without entering setup. Once the Comparator icon  appears, press the PRINT key to access the limit settings screens for the first comparator.

If the operator is a single value, only one limit value can be set for the comparator, and pressing the PRINT key again returns to the list of comparators. If the operator is a range, then the Limit screen is followed by the High Limit screen, from which the PRINT key exits back to the list of comparators. To edit parameters other than limits, Comparator configuration must be accessed in setup. Refer to the Numerical Data Entry section on page 2-11 for the method used to modify numerical values.

The comparator operator menu is organized as indicated in Figure 2-10.

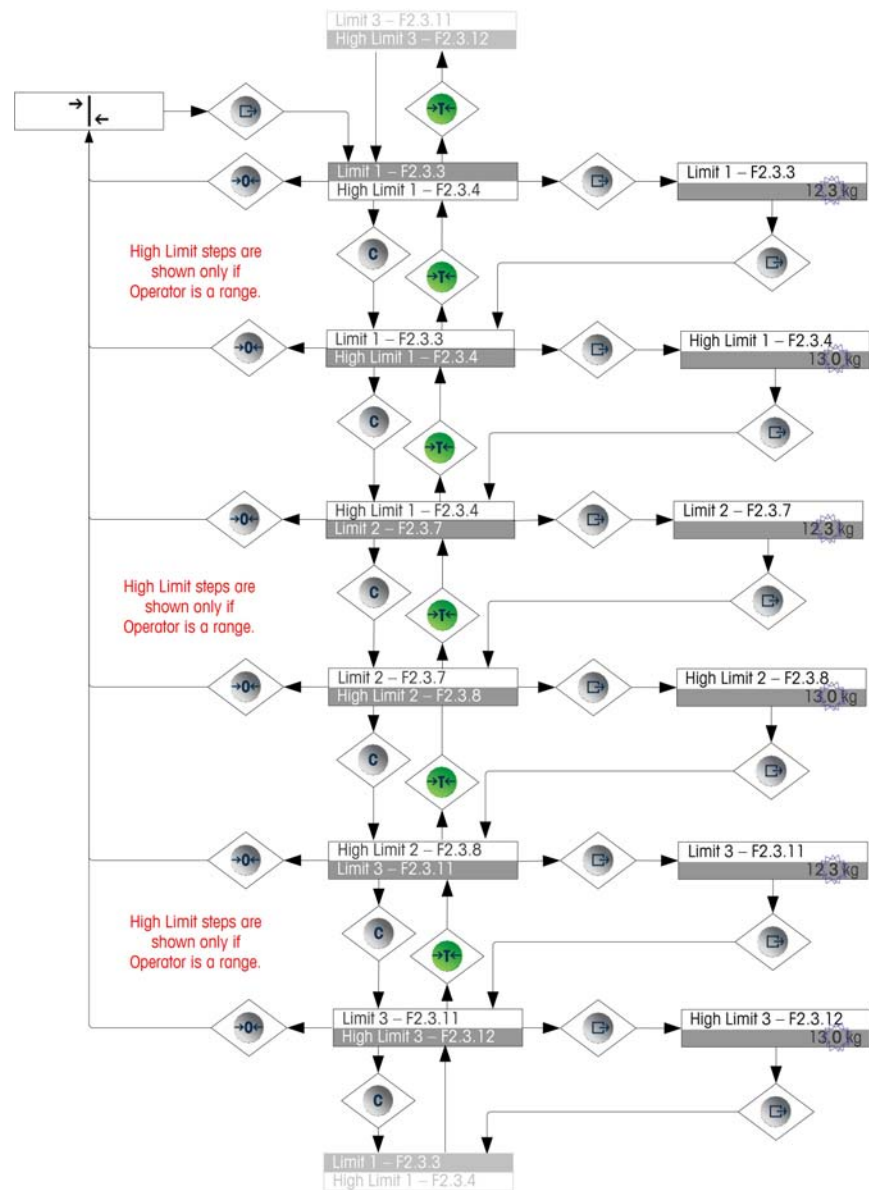

Figure 2-10: Comparator Setup

Information Recall Menu



The information recall function is always available in the operator menu. Once the Information Recall icon  appears, press the PRINT key to recall specific information about the terminal. In this menu, items are viewed in sequence by pressing the down (CLEAR) key or the up (TARE) key. Table 2-4 lists the elements of the Information Recall menu in the sequence in which they occur. Some items may not appear, depending on the configuration of the terminal.

Table 2-4: Information Recall Menu Tree Items

Item		Value/Explanation
Model	F6.1	The model number of the terminal (IND131 <i>or</i> IND331) is shown
S/N	F6.2	Serial number of the terminal as entered in the setup mode.
Base S/N	F6.3	Serial number of the attached scale base as entered using the InSite™ configuration tool or serially via the variable access. (It is not possible to enter this data from the IND131/IND331 keypad.)
ID1	F6.4	Series of up to three identification strings entered using the InSite™ configuration tool or serially via the variable access. (It is not possible to enter this data from the IND131/IND331 keypad.) The default values for these fields are: METTLER TOLEDO / Industrial / Terminal
ID2	F6.5	
ID3	F6.6	
H/W Info	F6.7	Indicates if the AC or DC version of the Main Board is used
H/W Info	F6.8	Indicates optional PLC interface type
H/W Info	F6.9	Indicates optional discrete I/O
S/W Info	F6.10	Information about the standard firmware version
Service	F6.11	A telephone number used to contact METTLER TOLEDO authorized service as entered via InSite or via the variable access
MCN	F6.12	Metrology Control Number used to indicate revisions to the metrology performance of the terminal
Approved	F6.13	Yes (1) <i>or</i> No (0) Indicates whether the terminal has been programmed as Approved for use in legal for trade applications.

Calibration Menu

If the Calibration function is enabled for the operator menu, Calibration can be performed without entering setup. The scale must also be programmed as NOT approved for the Calibration menu to operate.

With the Calibration icon  in view, press the PRINT key to access the calibration procedures. The following four sections and flow charts describe calibration options and procedures. Refer to the Numerical Data Entry section on page 2-11 for the method used to modify numerical values.

Zero Calibration

Scale zero is set simply by emptying the scale and running the "Set Zero" calibration routine, as indicated in Figure 2-11. The scale must be in the gross weight mode when zero is calibrated. If the net mode is displayed when the zero calibration is initiated, the tare value will be cleared automatically.

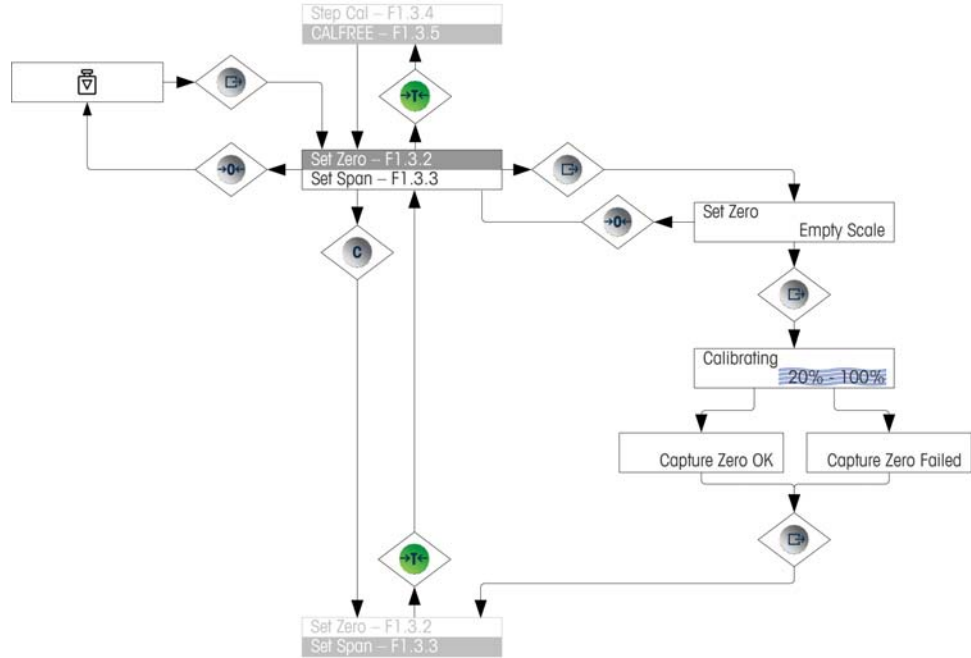

Figure 2-11: Zero Calibration

Span

The scale's span calibration can be determined either with or without a linearity adjustment. With linearity disabled, a single reference point is used to calibrate the scale. This is the normal method of span calibration. If linearity is enabled, an additional mid-range weight reference point is added to the adjustment procedure. Linearity can be enabled or disabled in the setup mode. Refer to the Numerical Data Entry section on page 2-11 for the method used to modify numerical values.

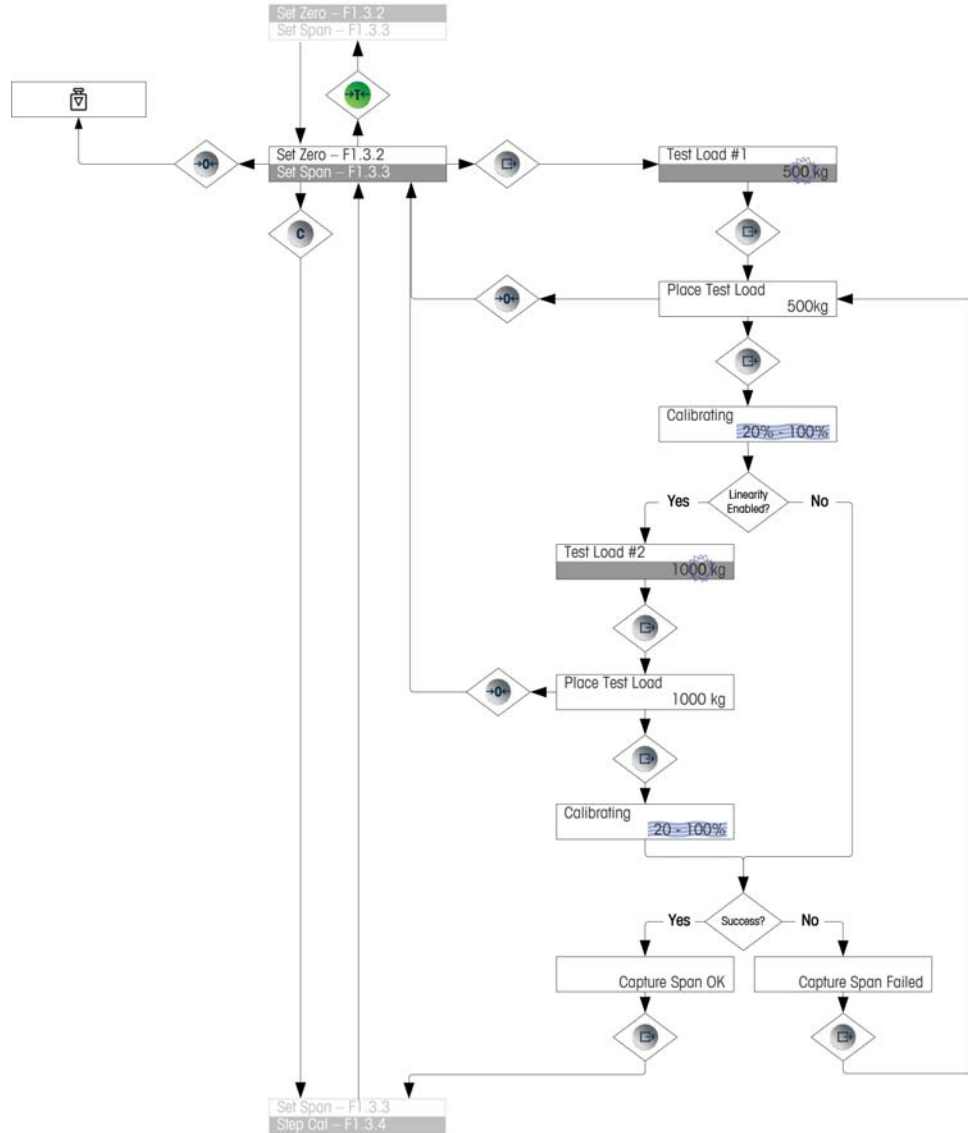

Figure 2-12: Span Calibration

Step Calibration

Step calibration is an iterative process in which a build-up or material substitution method of calibration is used to calibrate the span. This is typically used with large vessels where only a portion of the required calibration test weights can be placed on the scale at one time. Figure 2-13 shows the logic of the procedure.

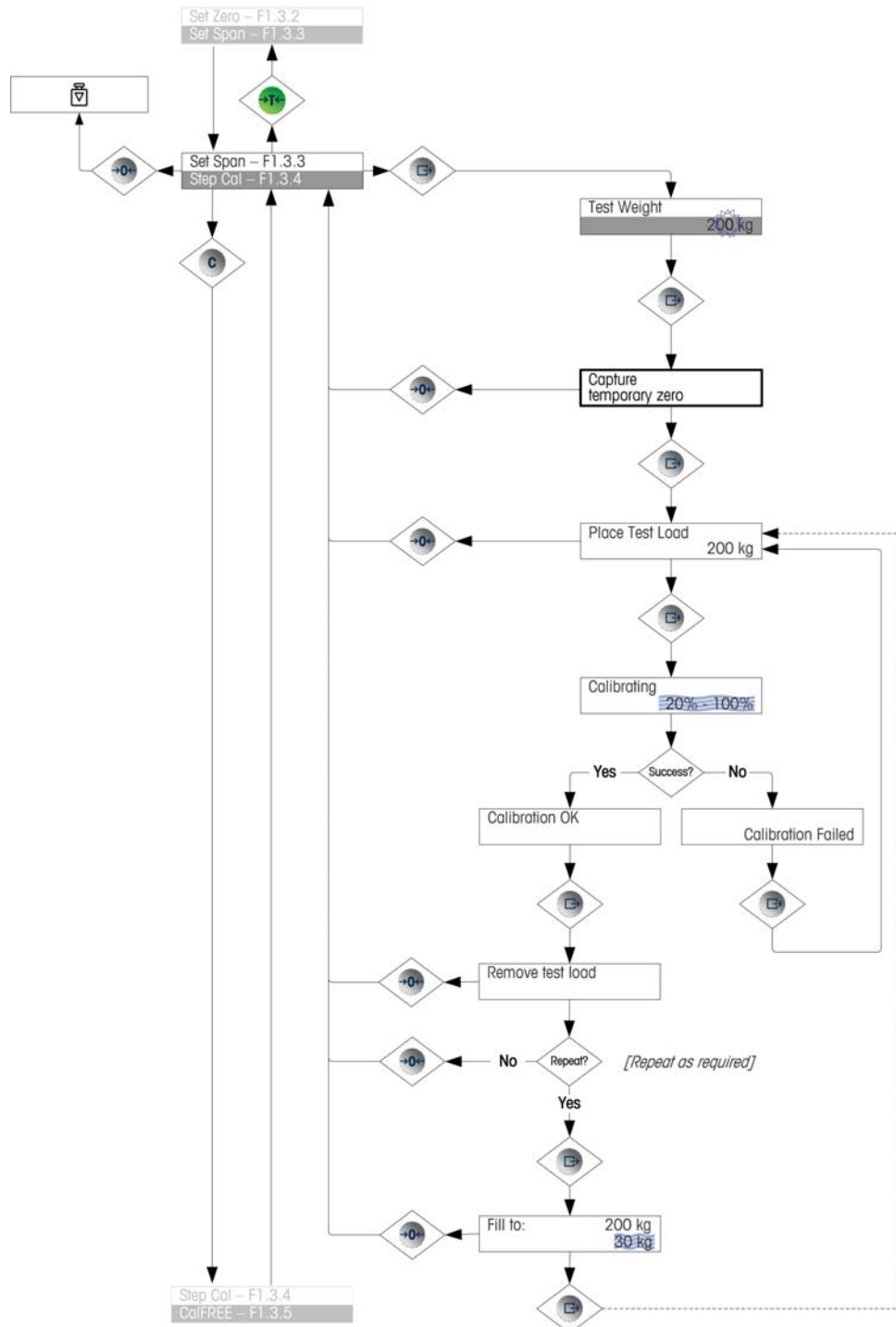

Figure 2-13: Step Calibration

CalFREE™

CalFREE allows the scale to be calibrated without the use of test weights. It requires the load cell capacity and output in mV/V to be entered. The system then calculates correct calibration for the scale. Figure 2-14 provides a visual representation of the CalFREE calibration procedure.

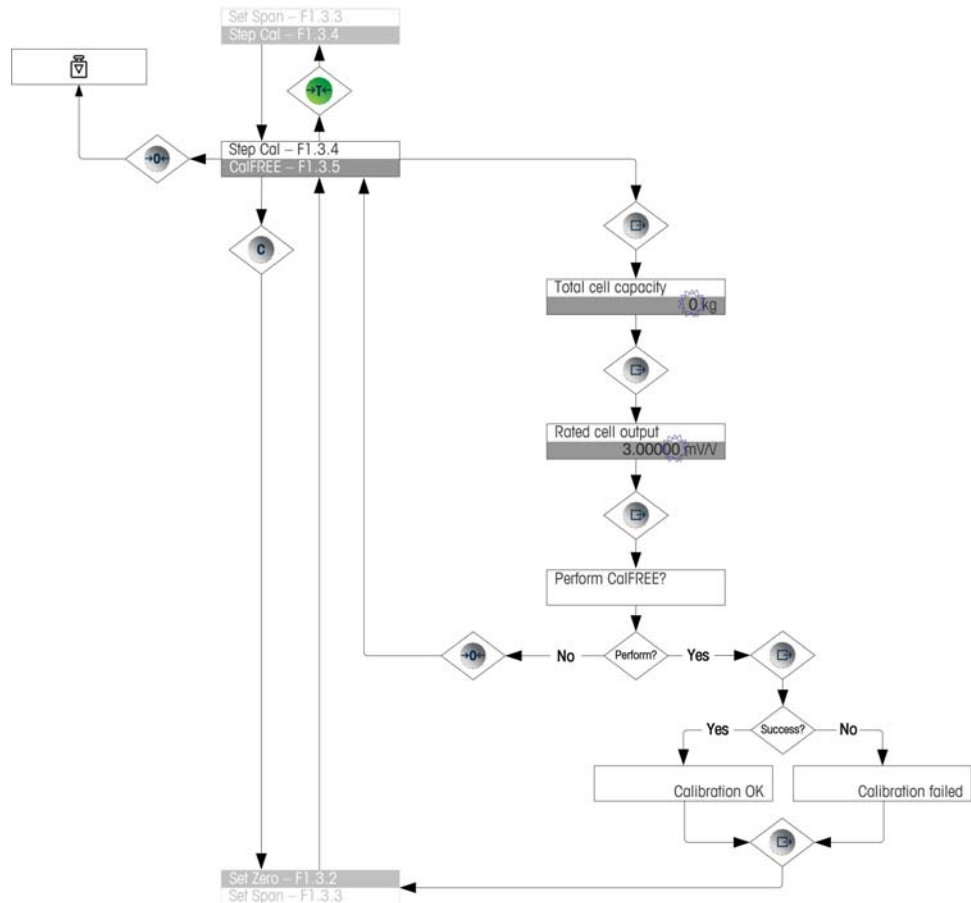



Figure 2-14: CalFREE

Setup Access

The last icon displayed in the operator menu accesses Setup , where all the terminal's programming parameters can be viewed and modified. Details of the setup mode are described in Chapter 3, **Configuration**.

It is not intended that operators enter the setup mode. After a weighing system is installed and is operational, it should not be necessary for an operator to access setup.

Note that a security password can be enabled in setup. When a password is set, it must be entered in order to access setup. This protects the setup parameters from inadvertent changes.

Chapter 3.0

Configuration

This chapter covers

- Setup Menu Tree
- Entering Setup Mode
- Exiting Setup Mode
- Overview of Setup
- Configuring Options

This chapter provides information about how to modify the IND1331/IND331 terminals' settings. It describes access to the setup mode, where functions can be enabled, disabled, or defined by entering parameter values or selecting from lists.

Setup Menu Tree

Parameters in the setup menu tree are accessed in the same manner as items in the Operator menu - either sequentially (at the same level), or by stepping down through the tree structure to a lower level. This section explains the use of the scale function keys to navigate the menus, to enter numerical parameters, and to select options from lists. A key to conventions used in the setup menu flow charts is also provided.

In this chapter, references are made to the "next higher menu level", which is accessed either using the ZERO key (to exit a menu) or, in some cases, by the PRINT key (where a setting is confirmed and a process concluded).

Use of Keys Within Menus

Overview of Navigation

The scale function keys double as navigation and data entry keys when the setup menu is accessed.

For menus where settings may be mode or options selected, the scale function keys work as indicated in Figure 3-1.

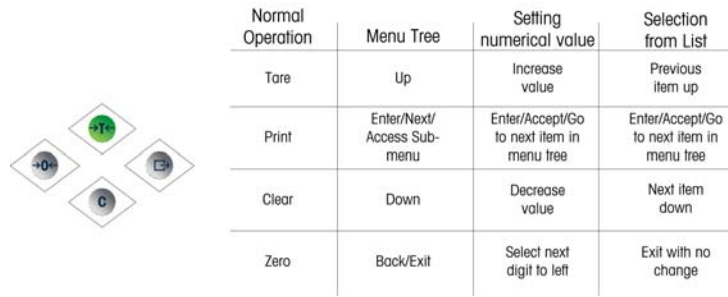

Figure 3-1: Navigating and Setting Parameters Using Scale Function Keys

Entering Numerical Parameters

Figure 3-2 shows how to set numerical values. Note that, whether or not the setting is altered, the PRINT key will confirm the currently displayed value and return the view to the next higher menu.

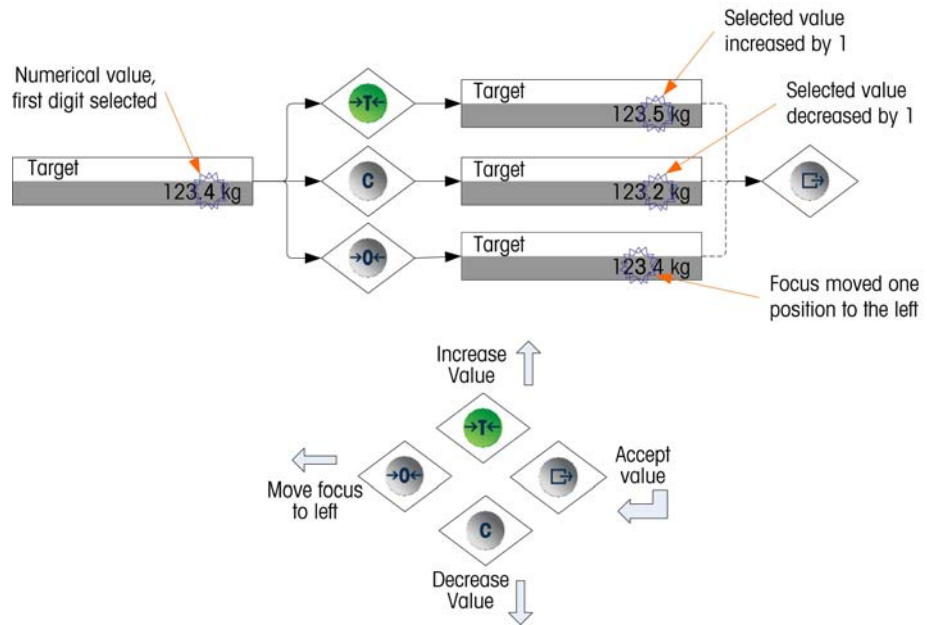

Figure 3-2: Setting Numerical Values

Making Selections from a List

Figure 3-3 details the method used to make a selection from a list. In this case, the ZERO key returns the view to the next higher level without making a change, while the TARE and CLEAR keys are used to move up and down through the list, with the selection being confirmed by pressing the PRINT key.

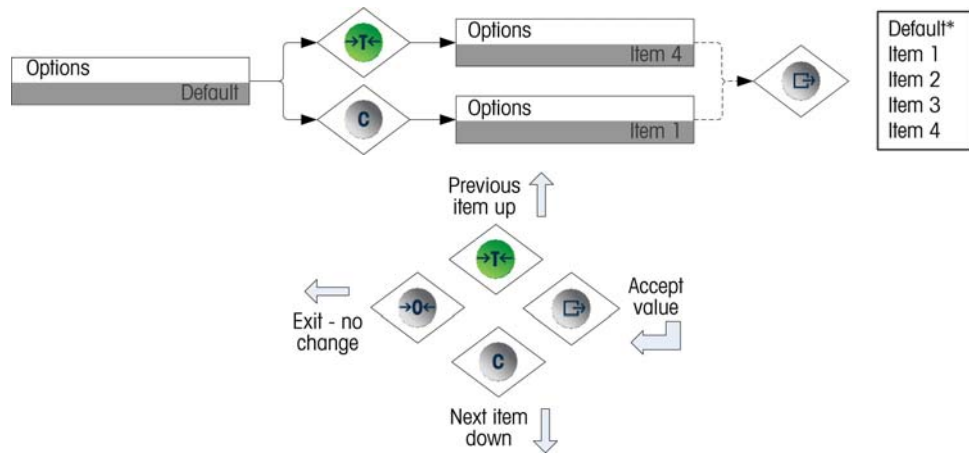



Figure 3-3: Selecting from a List

Entering Setup Mode

The setup menu of the IND131 and IND331 terminals is accessed by pressing and holding the PRINT scale function key. The screen will show the first icon in the Operator Menu. The number of icons in the Operator Menu depends on how the terminal is configured. The complete operator menu is described in Table 2-3 and shown in Figure 2-5 in the previous Chapter 2.0 - **Operation**.

After accessing the Operator Menu, continue to the Setup icon  then press PRINT to open the setup menu tree.

Security

Access to the configuration/setup mode of the terminal can be password protected if enabled in setup. A single password of up to 6 digits can be programmed. If enabled, the password will be prompted when the setup mode is accessed. The correct password must be entered in order to access the setup mode. If an incorrect password is entered, the display returns to the Setup icon. Refer to Figure 3-4 for an example of the password entry display.



Figure 3-4: Prompt for Password Entry

The operator level menu which provides access to target and comparator data entry is not protected by this password so operators can easily change operational parameters but configuration data can be protected.

Metrology Switch

Access to the metrology switch may be sealed in conformity with local regulations in "legal-for-trade" applications. Refer to Appendix A, **Installation**, for details about the metrology switch.

Exiting Setup

To return to the normal (run) mode, navigate back to the operator menu tree by pressing ZERO and then exit the operator menu by pressing the ZERO scale function key again. This is shown in Figure 3-5.

If the terminal has been programmed as approved, the metrology switch (SW1-1) must be switched "ON" before setup can be exited. If an exit of setup is attempted when the scale is approved and SW1-1 is "OFF", an error message of [Err 0015] is shown indicating the switch is unsecured and exit is prohibited.

Overview of Setup

There are five major branches in the setup menu tree:

- Scale
- Application
- Terminal
- Communication
- Maintenance

Details for each branch are provided in the following Configuration Options section. Figure 3-5 shows an overview of the setup menu tree, and indicates how to navigate between the branches. Note the use of the gray highlighted blocks to indicate focus. The line with the highlight is the branch that will be accessed when PRINT is pressed.

Depending on the terminal's language setup, **either** the label ("Scale") or the F code (F1) will appear. For clarity, both are shown in Figure 3-5 and throughout the configuration section of this manual. F-code parameter options are given in square brackets – e.g. [0].

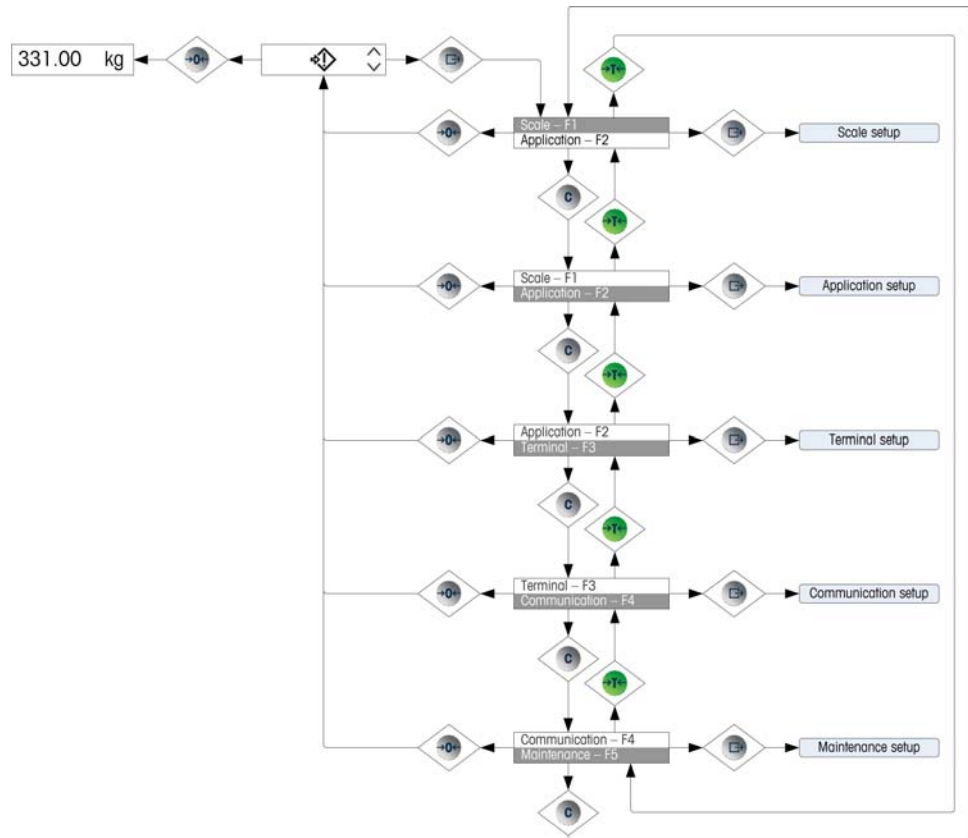

Figure 3-5: Overview of IND131/331 Setup Menu

Configuration Options

This section describes how to configure terminal options in the setup menu that are available under the five major branches of the setup tree.

If the terminal has been programmed to use F codes for setup instead of English, the selections for the parameters will also be shown in code. Appendix C of this manual provides a listing of the choices for each parameter. An explanation of what each choice corresponds to is also provided.

- If the metrology switch is in the approved position (SW1-1 = ON), access to certain parameters in the Scale branch is restricted to view only. If an attempt is made to change one of these parameters, the display will show an error

message of [Err 0007] which indicates that access is denied since the scale is approved.

Scale – F1

The **Scale** branch provides access to the configuration of the connected scale and includes the following sub-branches:

- Type
- Calibration
- Tare parameters
- Filter parameters
- Stability parameters
- Capacity and increment values
- Zero parameters
- Rate parameters
- Log or print threshold parameters

A Reset option is also provided, to enable a limited reset to the factory default settings for the Scale parameters.

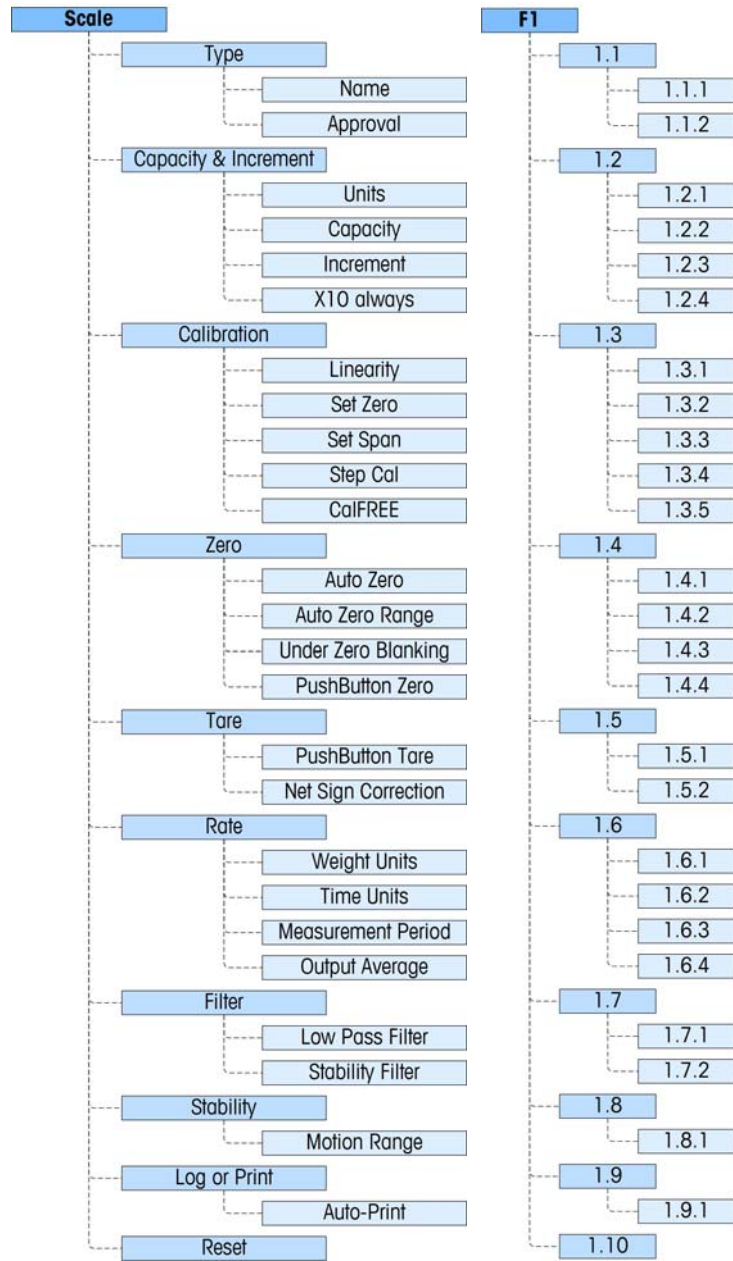

Figure 3-6: Scale Branch of Setup

Type – F1.1

The **Scale Type** sub-branch displays the name that was assigned to the scale and provides a selection list for the Approval mode.

Name – F1.1.1

The Name field shows what identification has been assigned to this scale. This field can be added to the print template for demand outputs. Because alphanumeric data entry is not possible in the IND131/331, the scale name must be entered using the InSite™ configuration tool.

Approval – F1.1.2

Approval refers to the metrological (weights and measures) approval configuration for the specific scale. The selection list can be set to: **None [0]** (default - no approval), **USA [1]**, **OIML [2]** and **Canada [3]**.

If an approval (USA, OIML, Canada) is configured and the metrology security switch, SW-1, is set to ON, access to certain parameters in the Scale setup branch in the menu tree will be restricted to view only for metrological parameters.

If an approval is selected but SW1-1 is not ON, it will not be possible to exit setup, and a message will appear: SWITCH UNSECURED! Setting SW1-1 to ON without selecting an approval will not secure the scale.

Capacity and Increment – F1.2

Use the **Capacity and Increment** setup menus to select the weight units, capacity and increment for the scale. The option to display a finer weight resolution (**x10 always**) can also be enabled or disabled from this set of menus.

Units – F1.2.1

Set the primary units by scrolling through the options and selecting from the choices of **None [0]** (no weight display shown on display), **g [1]** (grams), **kg [2]** (default – kilograms), **lb [3]** (pounds), **t [4]** (ton) or **ton [5]**. Only one weight unit is possible in the IND131/331 – unit switching is not a supported feature.

Capacity – F1.2.2

Enter the capacity value for the scale. Values from **1** to **9,000,000** are possible. The display will blank in an over capacity condition at 5 display divisions above this value. If the capacity entered (in conjunction with the increment size stored) results in more than 100,000 display divisions, the increment size will automatically be reduced so that the number of display divisions is below 100,000. Always check the increment size after making a change to the capacity.

Scale calibration should also be checked after a change of the capacity.

Increment – F1.2.2

Select the desired display increment size by scrolling through the available choices. The full range of increments are from **0.001** to **100**. The displayed choices are based on the capacity of the scale (previous parameter) and are limited by the terminal. The minimum number of resulting display divisions is 1000 and the maximum number is 100,000.

0 = 0.001	4 = 0.02	8 = 0.5	12 = 10
1 = 0.002	5 = 0.05	9 = 1	13 = 20
2 = 0.005	6 = 0.1	10 = 2	14 = 50
3 = 0.01	7 = 0.2	11 = 5	15 = 100

x10 Always – F1.2.4

The choices are **Enabled [1]** and **Disabled [0]** (default). During diagnostics of a weighing system, it is sometimes useful to expand the weight display resolution by 10 so a finer weight increment can be seen. This is intended for diagnostic purposes only. The terminal should not be used in the x10 expanded mode for normal operation. Some functionality (such as PLC data) may be disabled in this mode.

Calibration – F1.3

The **Calibration** menu provides access to linearity adjustment, zero and span calibration, step calibration and CalFREE calibration. Note that the zero, span, step calibration and CalFREE are also accessible from the Operator menu if enabled in the Terminal block of setup.

Linearity – F1.3.1

A linearity adjustment feature can be **Enabled [1]** or **Disabled [0]** (default) in this parameter. If enabled, a 3-point linearity adjusted span calibration process (zero, mid-weight and high-weight) will be used. If disabled, a standard 2-point span adjustment (zero and single span weight) will be used.

Set Zero – F1.3.2

Scale zero is set simply by emptying the scale and running the calibration routine. At the end of the zero capture routine, the display will indicate if the routine was successful or not. If there is motion on the scale during calibration, the display will indicate a dynamic weight adjustment and ask if the dynamic value should be used or not. Pressing the PRINT key accepts the dynamic calibration and pressing the ZERO key reverts the zero reference back to the previously calibrated value.

Set Span – F1.3.3

The scale's span can be defined either with or without linearity. If 3-point linearity is enabled, an intermediate test weight is used in addition to the full-capacity test weight. Including zero, this provides 3 points of reference for the span adjustment. As much test weight as possible should be used for calibration in order to help assure accuracy.

Step Calibration – F1.3.4

Step calibration initiates a procedure that enables a "build-up" or "substitution" method of calibration intended for use on large tanks and hoppers. During the step calibration, the same amount of test weight is added for each step of the calibration procedure.

To perform a step calibration:

1. Select the **Step Cal** menu item and press the PRINT key.
2. In the Test Weight display, enter the target weight for the test load (the same amount of test load weight is used in each step).

3. Press the PRINT key. A message appears – **“Capture temporary zero”**. This step allows zeroing of any extra equipment required to secure the test weights during the calibration procedure such as chains or shelves. If used, add this equipment to the scale then press PRINT to continue. If no extra equipment will be used, press PRINT with nothing added to the scale.
4. When prompted in the **“Place Test Load”** menu, which reflects the test weight value previously entered place the test load on the scale and press the PRINT key.
5. The display will show **“Calibrating”**, together with a live indication of progress. Once the process is complete, the display will show either **“Calibration OK”** or **“Calibration Failed”**. If the calibration was successful, pressing PRINT moves the view to the next step. If the calibration failed, pressing PRINT will return the view to the **“Place Test Load”** prompt.
6. The display now prompts to **“Remove test load”** from the scale. Remove the test weights and press PRINT when complete. If you have completed multiple calibration steps and wish to exit the Step Calibration procedure, press ZERO to exit the routine at this time.
7. If additional calibration steps are required, press PRINT and the screen now prompts **“Fill to:”**, and indicates the target amount of material to be added to the tank or hopper as a substitute weight. On the bottom of this display, the active weight is shown. Fill the tank or hopper as close as possible to the **Fill to: weight value** then press PRINT to continue.
8. The procedure returns to step 4 (**“Place Test Load”**) above. Refer back to steps 4 – 7 as many times as the sequence is run. This procedure can be repeated until the scale capacity is reached. Pressing ZERO at any step in the process will exit the Step Calibration procedure.

CalFREE – F1.3.5

CalFREE allows the scale to be calibrated without the use of test weights. It requires the total load cell capacity and output rating in mV/V to be manually entered then the system calculates correct calibration for the scale.

To perform calibration of span using CalFREE:

9. Access the CalFREE menu and press the PRINT key to initiate the procedure.
10. The display prompts **“Total cell capacity”**. Enter the total load cell capacity of all the load cells used on the scale then press PRINT.
 - The total load cell capacity should be entered here. For example, for a tank with three 5000 kg cells, cell capacity would be 3 x 5000 kg or 15000 kg. The weight unit displayed will be the same unit selected for the scale capacity. It cannot be changed.
11. Next, the terminal will prompt **“Rated cell output”**. It is important that the most accurate value possible for the millivolt output rating be used. This is typically a value which includes data to 5 positions right of the decimal point. After entering the millivolt rating of the load cell system, press PRINT.
 - If multiple load cells are used, the average output of all cells should be entered here. To calculate the average, add the millivolt ratings of all load

cells together and then divide by the number of cells. Enter the result in the step above.

12. When prompted with "Perform CalFREE?", press the PRINT key to perform CalFREE or the ZERO key to exit the calibration procedure without executing CalFREE.
13. If the calibration operation was successful, a verification message that reads "Calibration OK" displays. If the calibration operation was not successful, an error message that reads "Calibration Failed" displays. If the calibration fails, repeat the CalFREE procedure. Press PRINT to accept the message and return to the menu tree.

Zero – F1.4

This section provides access to parameters for Auto Zero, under zero blanking and power-up and pushbutton zero ranges.

Auto Zero – F1.4.1

Auto Zero Maintenance is a feature that tracks zero when the scale is empty. It compensates for conditions such as debris falling onto a scale platform. Select from the list whether Auto Zero is **Disabled [0]**, whether it is active only in the **Gross** weight mode [**1**] (the default setting), or whether it is active in both **Gross and Net [2]** weight modes.

Auto Zero Range – F1.4.2

The Auto Zero Range programs the range from the center of zero in which the automatic zero maintenance will operate. If the weight on the scale exceeds the number of display divisions programmed for the range, AZM will not operate. If the weight is within this range and the scale is at no motion, the AZM will slowly adjust zero back to the center of zero. The choices are **0.5d [0]**, **1d [1]**, **3d [2]** and **10d [3]**.

Under Zero Blanking – F1.4.3

The Under Zero Blanking function programs the point at which an under-zero condition blanks the display with just dashes showing. This feature may be **Disabled [0]** (the display will not blank when the weight is below zero), or set to **5 divisions [1]** (the default value).

Pushbutton Zero – F1.4.4

This step selects the range (plus and minus) from the calibrated zero reference weight in which the front panel ZERO key will operate to rezero the scale. The selections include **Disabled [0]**, **+/-2% [1]**, and **+/-20% [2]**.

Tare – F1.5

Tare is used to subtract the weight of an empty container from the gross weight on the scale to determine the net weight of the contents. Tare is inhibited if the scale is in motion.

Pushbutton Tare – F1.5.1

When pushbutton tare is **Enabled [1]** (the default setting), the TARE scale function key **→T←** can be pressed when an empty container is on the scale and that weight will be stored as the tare weight. If Pushbutton Tare is **Disabled [0]**, the front panel TARE key will not function.

Net Sign Correction – F1.5.2

Net sign correction will operate to switch the gross and tare weight values so that the resulting net weight is always positive and affects the printed data output and the displayed weight. Continuous data output will continue to show a negative net weight value. Net Sign Correction can be **Enabled [1]** or **Disabled [0]**. By default, it is **Disabled**.

Rate– F1.6

A rate of weight change, expressed as change in weight units per time unit, may be programmed for use with the comparators and is available via the various PLC interfaces.

The following parameters can be configured for the rate:

Weight Units – F1.6.1

The weight unit can be set to **None [0]** (default) which disables the rate calculation or can be set to **Primary [1]** weight units which enables the rate calculation.

Time Units – F1.6.2

Time Units may be set to **Seconds [0]**, **Minutes [1]** or **Hours [2]**. The default value is Seconds.

Measurement Period – F1.6.3

The Measurement Period value sets the frequency of weight measurements. **1 second [1]** is the default value. Other options are **0.5 [0]** and **5 [2]** seconds.

Output Average – F1.6.4

Output from the rate function is set by a computed rolling average of measurements. Available values are **1 [0]**, **5 [1]**, **10 [2]**, **30 [3]** and **60 [4]** seconds, with a default value of 1 second. The Output Average value should be sufficiently larger than the Measurement Period to allow the terminal to take multiple measurements for each average.

Filter – F1.7

The IND131/331 terminals have a low-pass, multi-pole vibration filter that can be set for several conditions when using analog load cells. The heavier the filtering, the slower the display settling time will be.

Low Pass Filter – F1.7.1

Low Pass filter selections include **Light [0]**, **Medium [1]** (default) and **Heavy [2]**. This parameter sets the amount of filtering that is applied to the weigh. The heavier the filter applied, the more stable the weight will be, but the longer the settling time required for the scale.

Stability Filter – F1.7.2

The stability filter works in conjunction with the low pass filter to provide a more stable final weight reading. The display will appear to respond sluggishly due to the additional filtering applied to stable weights. The stability filter should only be used in transaction weighing applications, since the nonlinear action of the filter switching may cause inaccurate cutoffs in batching or filling applications. The stability filter can be **Enabled [1]** or **Disabled [0]** – by default, it is disabled.

Stability – F1.8

The IND131/331 terminals include a stability detector (weight in motion). The Stability setup menu enables setting a motion range.

Motion Range – F1.8.1

Sets the amount of motion (in divisions) that the weight is permitted to fluctuate and still have a no-motion condition. This affects the zero, tare and print functions. Available values are **Disabled [0]**, **1 division [1]** (the default) and **3 [2] divisions**.

Setting the motion range to **Disabled** will disable motion detection in the terminal so that regardless of the weight change, the terminal will not be able to detect motion.

Log or Print – F1.9

The **Log or Print** setup menu defines whether or not data is output to a printer automatically. Normal demand mode printing occurs whenever a print request is made, providing there is no motion on the scale and zero has been captured (a negative gross weight will not be printed).

Auto Print – F1.9.1

Auto Print may be **Disabled [0]** (the default) or set to **After target [1]**. If **After target** is selected, a demand print command is issued when a target is met and a stable condition established.

Reset – F1.10

The **Reset** menu enables the scale setup block of values to be reset to factory default settings. To initiate a reset, press the PRINT key. A confirmation message appears, reading "**WARNING Reset Scale?**" Either press PRINT again to confirm the action, or ZERO to return to the Scale menu without resetting the values.

After a reset attempt, a status message of "**Reset Successful**" or "**Reset Failed**" will be shown indicating the status of the reset. Press PRINT to clear the message and return to the Reset menu branch.

- Scale reset does NOT include the reset of metrologically significant parameters –approval, weight units, capacity, increment, or calibration data. This data is reset only by performing a Master Reset with DIP switch 1-2 in its ON position and reset calibration switch 1-4 in the ON position.

Application – F2

Use application setup menus to configure the following items:

- Target Operation
- Target Values
- Comparators
- Discrete I/O

Figure Figure 3-7 shows the layout of the complete Application branch.

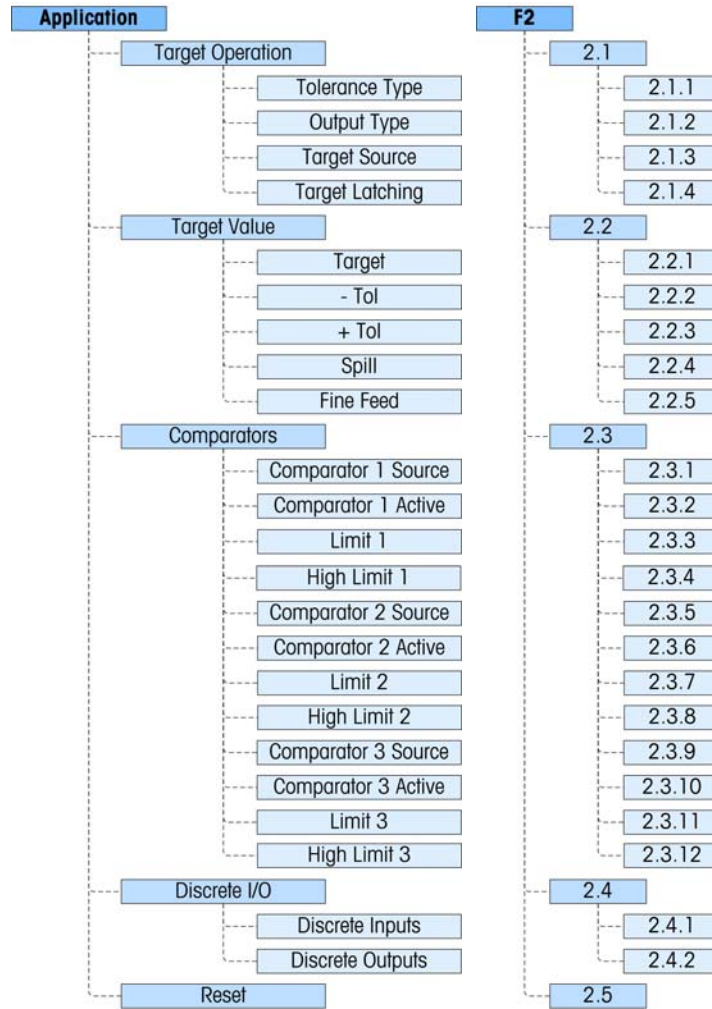

Figure 3-7: Application Branch of Setup

Target Operation – F2.1

This setup menu is used to configure the way Targets function in the terminal. The parameters that must be set are:

- Tolerance Type
- Output Type
- Target Source
- Target Latching

Tolerance Type – F2.1.1

The default value is **Weight Deviation [0]**, which uses an absolute difference in weights for the target tolerance. Alternatively, Tolerance Type can be set to **% of Target [1]**, which uses a percentage of the target value to set the tolerance.

Output Type – F2.1.2

Either **Concurrent [0]** (the default) or **Independent [1]** output types can be selected as the operation method of the target outputs.

Target Source – F2.1.3

The Target Source may be either **Displayed Weight [0]** (the default) or **Gross Weight [1]**.

Target Latching – F2.1.4

Target Latching can be **Enabled [1]** (the default) or **Disabled [0]**. If disabled, the target will work like a comparator without any latching logic

Target Values – F2.2

Target values may also be entered from the operator menu, if Target Access is enabled (refer to the **Menu Keys** section of **Terminal**, below). For applications where the target values do not change, they can be entered in setup and the Target Access for the operator can be disabled.

Target control is available via the Discrete I/O and the feeding status is reported in the standard PLC interfaces.

Target – F2.2.1

Enter the target value. The Target is an absolute weight value, expressed in the default weight units.

Negative and Positive Tolerance (-Tol and +Tol) – F2.2.2, F2.2.3

The Target Tolerance values set the band around the absolute target value within which the target is considered to have been met. This figure is expressed as an absolute value or as a percentage of the target, depending on the setting selected at **Application | Target Setup | Tolerance Type**.

Spill – F2.2.4

The Spill value is a weight value used to compensate for material in the process of transfer when the Target is met and the output enabling the feed is turned off. It is expressed in the default weight units.

Fine Feed – F2.2.5

The Fine Feed value programs the amount of material that will be fed at the slower feed rate in a 2-speed filling system. If the Fine Feed value is programmed as "0", then the target is reduced to a single speed control system.

Comparators – F2.3

The **Comparators** menus permit the configuration of a maximum of three simple coincidence comparators controlled either by a limit value or by comparison with a range. They are used as an assignment for Discrete I/O outputs and the status is also available via the PLC interface.

Each of the three comparators is configured in the same way, one after the other. In the sections immediately below, "Comparator *n*" is used to signify that the same settings are available for Comparators 1, 2 and 3.

Note that the limit and high limit values for the Comparators can also be set from the operator menu if enabled. The Source and Active parameters of Comparators is configured here in Setup.

Comparator *n* Source – F2.3.1, F2.3.5, F2.3.9

The Source setting determines the basis for the comparison made by the Comparator. The default value is **Disabled [0]**. To use a Comparator, this setting must be changed to **Displayed Weight [1]**, **Gross Weight [2]**, or **Rate [3]**.

Active – F2.3.2, F2.3.6, F2.3.10

The active operator for the Comparator must be selected as one of the following:

Table 3-1: Active Operators

Active Symbol	F-code parameter	Description
<	0	Output is active when source value is less than the programmed limit (default value)
<=	1	Output is active when source value is less than or equal to the programmed limit
=	2	Output is active when source value is equal to the programmed limit
>	3	Output is active when source value is greater than the programmed limit
=>	4	Output is active when source value is equal to or greater than the programmed limit

Active Symbol	F-code parameter	Description
<>	5	Output is active when source value is NOT equal to the programmed limit
<>	6	Output is active when source value is outside the range of the programmed limit and high limit
>__<	7	Output is active when source value is within the range of the programmed limit and high limit

Limit – F2.3.3, F2.3.7, F2.3.11

The Limit either sets the target weight value to which the actual source value is compared, or the lower target value for the range to which the currently measured source value is compared.

High Limit – F2.3.4, F2.3.8, F2.3.12

The High Limit is available only when the Active value is set to a range. It defines the upper target value for the range to which the currently measured source value is compared. Its value must be higher than the Limit – if a lower value is entered, the terminal will show an “Err 0010” message and the PRINT key must be pressed to clear the error message and make a valid entry.

Discrete I/O – F2.4

Discrete I/O setup menus allow the configuration of 2 inputs and 4 outputs. The Discrete I/O option does not have to be installed to program this functionality.

Discrete Inputs – F2.4.1

The Discrete Input menus display discrete input polarity and assignments for Input 1 and Input 2. The two Inputs are configured in the same way.

Polarity – F2.4.1.1, F2.4.1.3

The inputs can be programmed to accept either a + True [0] or – True [1] polarity level as “ON”. The default is + True.

Assignment – F2.4.1.2, F2.4.1.4

Options for input assignment are:

- None (default) [0]
- Clear Tare [1]
- Keypad Disable [2]
- Print [3]
- Tare [4]
- Target Abort [5]
- Target Start [6]
- Zero []

* **Keypad Disable** is designed to be continuously activated by a simple press-and-hold or key and lock mechanism

Discrete Outputs – F2.4.2.1, F2.4.2.2, F2.4.2.3, F2.4.2.4,

For each **Discrete Output**, menus permit an assignment to be selected from the following options:

- None (default) [0]
- Center of Zero [1]
- Comparator 1 [2]
- Comparator 2 [3]
- Comparator 3 [4]
- Fast Feed [5]
- Feed [6]
- In Tolerance [7]
- Motion [8]
- Net [9]
- Over Capacity [10]
- Under Zero [11]

Reset – F2.5

The **Reset** menu enables the Application setup block of values to be reset to factory default settings. To initiate a reset, press the PRINT key. A confirmation message appears, reading “**WARNING Reset Application?**” Either press PRINT again to confirm the action, or ZERO to return to the **Application** menu without resetting the values.

After a reset attempt, a status message of “**Reset Successful**” or “**Reset Failed**” will be shown indicating the status of the reset. Press PRINT to clear the message and return to the Reset menu branch.

Terminal – F3

Setup parameters available through the Terminal menu include:

- Set Serial Number
- Set Screen Saver
- Region Language
- User Access
- Menu Keys

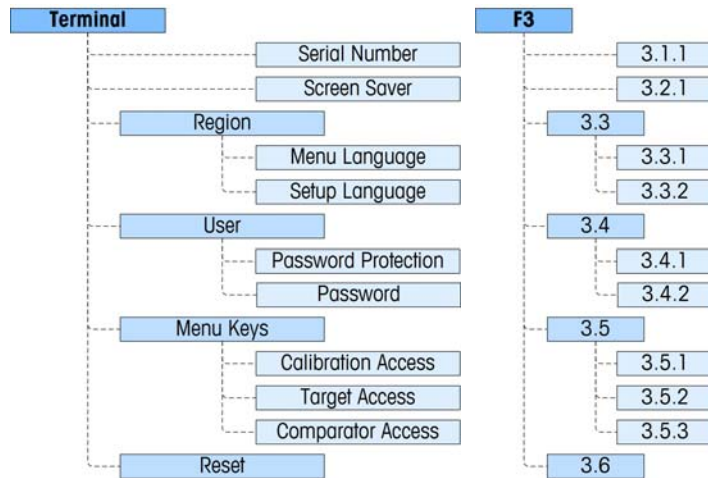

Figure 3-8: Terminal Branch of Setup

Serial Number – F3.1.1

The Serial Number setup menu enables the entry of an eight-digit terminal serial number.

Screen Saver – F3.2.1

The Screen Saver menu sets the number of minutes that must elapse with no scale motion and no keypad activity before the display blanks and the screensaver is shown. The parameter is selected from a list. Options are **Disabled [0]** (the default), **1 [1]**, **5 [2]** and **10 [3]** minutes.

Region – F3.3

The Region menus are used to configure the Menu Language and Setup Language for the terminal.

Menu Language – F3.3.1

Menu Language sets the language used in the operator menus (such as **Target** and **Comparators**). Options are **English [0]** (the default), **F codes [1]**, **French [2]**, **German [3]**, **Italian [4]** and **Spanish [5]**. If F codes is selected, the text in the operator menu will be replaced with numeric codes.

Setup Language – F3.3.2

The Setup Language menu can be configured to appear either with **English** labels **[0]** (the default), or with **F codes [1]**. Select the value from the list. If F codes is selected, the text in the operator menu will be replaced with numeric codes.

User – F3.4

This group of menus enables/disables the use of a protective password when entering the setup mode. This helps protect the setup mode from unintentional or inadvertent changes.

Password Protection – F3.4.1

The User branch allows selection of password protection for the setup mode. If **Disabled [0]** (default), the setup mode can be entered normally. If **Enabled [1]**, a password code must be entered before access is granted to the setup mode to change parameters.

Password – F3.4.2

If password protection is enabled in the previous step, this parameter allows entry of the actual password. A numeric value up to six characters in length can be entered to protect setup mode access.

Menu Keys – F3.5

The **Menu Keys** parameters determine which of the selectable operator menus are accessible to the operator when the PRINT key is pressed and held while the run (normal) screen is displayed. The Information Recall and Setup icons are always available in the Operator menu.

Calibration Access – F3.5.1

The default value is **Disabled [0]**. To provide operator level access to the Calibration menu via the  icon, select **Enabled [1]**.

Target Access – F3.5.2

The default value is **Disabled [0]**. To provide operator level access to the Target value menu via the  icon, select **Enabled [1]**.

Comparator Access – F3.5.3

The default value is **Disabled [0]**. To provide operator level access to the Comparator value menu via the  icon, select **Enabled [1]**.

Reset – F3.6

The **Reset** menu enables the Terminal setup block of values to be reset to factory default settings. To initiate a reset, press the PRINT key. A confirmation message appears, reading “**WARNING Reset Terminal?**” Either press PRINT again to confirm the action, or ZERO to return to the **Terminal** menu without resetting the values.

After a reset attempt, a status message of “**Reset Successful**” or “**Reset Failed**” will be shown indicating the status of the reset. Press PRINT to clear the message and return to the Reset menu branch.

Communication – F4

Setup parameters available through the **Communication** menu include:

- Output Template definition
- Connections configuration
- Serial port parameters
- PLC Interface setup

▣ Note that if a COM2 or a PLC option is not installed, those specific setup parameters will not be displayed

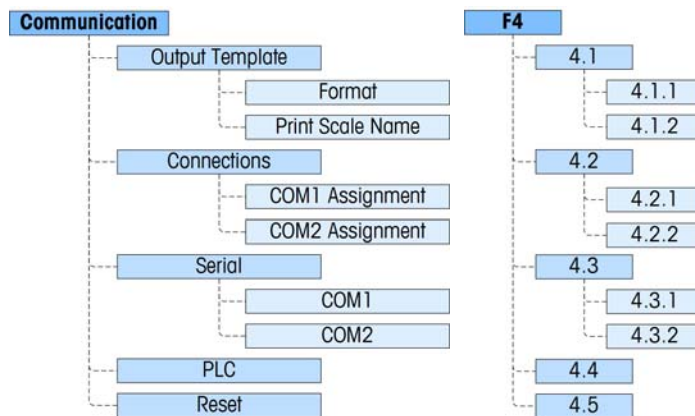

Figure 3-9: Communication Branch of Setup

Output Template – F4.1

The format for the demand print output of the terminal can be configured using the following menus.

Format – F4.1.1

The format of the output can be selected from **Displayed Weight [0]** (gross weight or net weight only - depending if tare was taken), **GTN (Gross Tare Net) single line [1]** and **GTN multiple lines [2]**. The default is **GTN multiple lines**.

Print Scale Name – F4.1.2

Transmitting of the scale name (set using InSite) at **Scale I Type I Name** can be **Enabled [0]** or **Disabled [1]** (the default), depending on whether the name should appear in the output.

Connections – F4.2

Connections for COM1 and, if installed, COM2 can be set from these menus. Options are the same for both COM1 and COM2 except for the following two exceptions:

- COM1 has an additional assignment selection of Variable Access
- COM2 includes an additional parameter for the interface type.

COM n Assignment – F4.2.1, F4.2.2

The COM Assignment is selected from a list, which includes the following options: **None [0]**, **Continuous Output [1]**, **Continuous-Extended Output [2]**, **Demand Output [3]** (the default), **SICS [4]** and **Variable Access [5]** (COM1 only).

If the Assignment is **Continuous** or **Continuous-Extended**, the Checksum menu is shown next.

Checksum – F4.2.1.1, F4.2.2.1

A Checksum character can be **Enabled [1]** or **Disabled [0]** (the default) for the continuous output string.

Serial – F4.3

Serial communication setup menus provide access to the communication parameters for the serial ports COM1 and, if installed, COM2. The COM2 port is only shown if the option board has been installed.

COM1 and COM2 – F4.3.1, F4.3.2

Use the COM1 and COM2 menus to configure the parameters for serial ports. Configuration options are the same for both ports.

Baud Rate – F4.3.1.1, F4.3.2.1

Use the Baud selection menu to set the baud rate for the serial port. Options are:

300 [0]	1200 [2]	4800 [4]	19200 [6]	57600 [8]
600 [1]	2400 [3]	9600 [5]	38400 [7]	115200 [9]

The default is 9600 baud.

Data Bits – F4.3.1.2, F4.3.2.2

Use the Data Bits menu to select the number of data bits to be used on the serial port – options are 7 [0] or 8 [1] (the default).

Parity – F4.3.1.3, F4.3.2.3

Use the Parity menu to set the parity to None [0] (the default), Odd [1], or Even [2] for the serial port.

Interface (COM2 only) – F4.3.2.4

The COM2 port must be set to RS-232 [0] (the default) when connecting to an RS-232 device or set to RS-485 [1] when connecting to an RS-485 device. For uni-directional connection of an RS-422 device, select the RS-232 interface type. Note that bi-directional communication is not possible when connected to an RS-422 device.

PLC – F4.4

The PLC parameter menu is only available when a PLC option is installed. The menu choices will vary depending upon which type of PLC interface option has been installed. The supported types include:

- None [0]
- PROFIBUS [2]
- EtherNet/IP - Modbus TCP [3]
- DeviceNet [4]
- A-B RIO [5]
- Analog Output [6]

PROFIBUS – F4.4.1

This block is used to configure the PROFIBUS interface option and data format. The two branches in this group are PROFIBUS and Data Format.

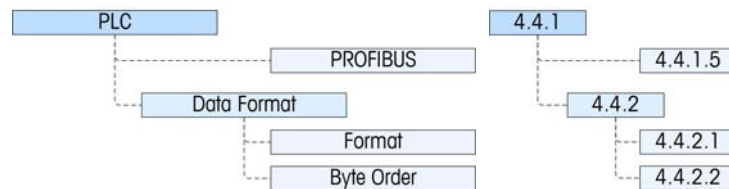

Figure 3-10: Setup Menu for PROFIBUS

Additional interface information and programming examples can be found in the **IND131/IND331 Terminal PLC Interface Manual**, which is included on the documentation CD.

PROFIBUS – F4.4.1

Provides access to the node address for the terminal. Note that the network baud rate is automatically determined by the terminal.

Node Address – F4.4.1.5

Each IND131 or IND331 Terminal connected to the network represents one physical node. This address is determined by the system designer, then configured in the terminal by entering the appropriate number (1 to 125) in the Node Address menu.

Data Format – F4.4.2

Provides access to the Format and Byte Order parameters.

Format – F4.4.2.1

The Format menu allows a data format to be selected from a list. Options are **Division [0]**, **Floating Point [1]** and **Integer [2]** (the default).

Byte Order – F4.4.2.2

This parameter selects the order in which the data bytes and words will be presented in the PLC data format. The choices are **Byte Swap [0]** (the default), **Standard [1]**, **Word Swap [2]** and **Double Word Swap [3]**.

- **Byte Swap** makes the floating point format compatible with S7 PROFIBUS.
- **Standard** makes the floating point format compatible with PLC 5.
- **Word Swap** takes the IEE 754 single-precision floating point format and swaps the two words in the 32-bit double word. This format is compatible with RSLogix 5000 processors.
- **Double Word Swap** takes the IEE 754 single-precision floating point format and swaps the two words plus byte swaps in the 32-bit double word. This format makes floating point data compatible with Modicon Quantum processors.

EtherNet / IP and Modbus TCP – F4.4.1

This block is used to configure the Ethernet/IP and Modbus TCP interface option and data format. Both of these interfaces are supported from the same interface board. The format of the data can be configured to be compatible with either interface type. The two branches in this group are Ethernet/IP - Modbus TCP and Data Format.

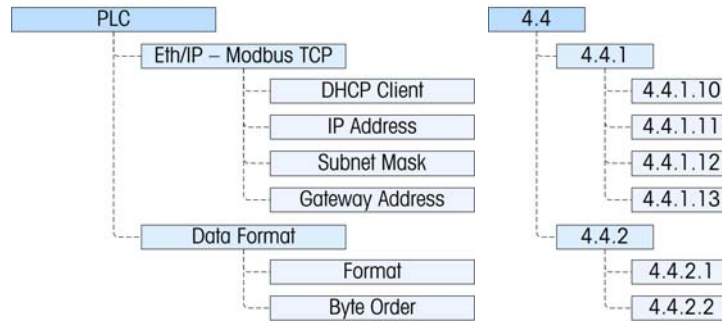

Figure 3-11: Setup Menu for Ethernet/IP and Modbus TCP

Additional interface information and programming examples can be found in the IND131/IND331 Terminal PLC Interface Manual, which is included on the documentation CD.

Eth/IP - Modbus TCP – F4.4.1

Provides access to the DHCP and network address menus used to set up the Ethernet/IP and Modbus TCP option.

DHCP Client – F4.4.1.10

Note: DHCP has not been implemented at this time, and will always be Disabled [0].

This setting determines if the address information for the terminal will be automatically assigned by the network when connected or if a static address will be used.

IP Address – F4.4.1.11

The IP address for the terminal can be viewed (if DHCP is Enabled) or entered (if DHCP is Disabled). The default value is 192-168-000-001

Subnet Mask – F4.4.1.12

The Subnet Mask address for the terminal can be viewed (if DHCP is Enabled) or entered (if DHCP is Disabled). The default value is 255-255-255-000.

Gateway Address – F4.4.1.13

The Gateway address for the terminal can be viewed (if DHCP is Enabled) or entered (if DHCP is Disabled). The default value is 000-000-000-000.

Data Format – F4.4.2

Provides access to the Format and Byte Order parameters.

Format – F4.4.2.1

From this menu, select a data format for the Ethernet network. Options are **Division** [0], **Floating Point** [1] and **Integer** [2] (the default).

Byte Order – F4.4.2.2

This parameter selects the order in which the data bytes and words will be presented in the PLC data format. The choices are **Byte Swap** [0], **Standard** [1], **Word Swap** [2] (the default) and **Double Word Swap** [3].

- **Byte Swap** makes the floating point format compatible with S7 PROFIBUS.
- **Standard** makes the floating point format compatible with PLC 5.
- **Word Swap** takes the IEE 754 single-precision floating point format and swaps the two words in the 32-bit double word. This format is compatible with RSLogix 5000 processors.
- **Double Word Swap** takes the IEE 754 single-precision floating point format and swaps the two words plus byte swaps in the 32-bit double word. This format makes floating point data compatible with Modicon Quantum processors.

DeviceNet – F4.4.1

This block is used to configure the DeviceNet interface option and data format. The two branches in this group are DeviceNet and Data Format.

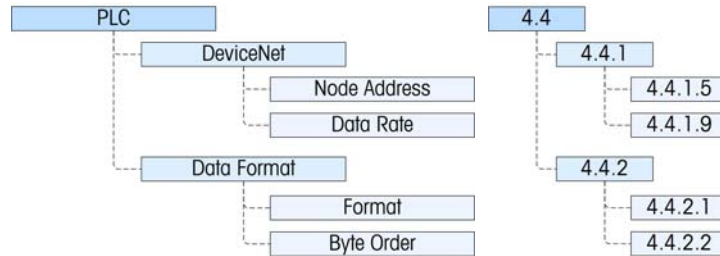

Figure 3-12: Setup Menu for DeviceNet

Additional interface information and programming examples can be found in the IND131/IND331 Terminal PLC Interface Manual, which is included on the documentation CD.

DeviceNet – F4.4.1

Provides access to the node address and data rate menus used to set up the DeviceNet option.

Node Address – F4.4.1.5

Each IND131/331 Terminal connected to the network represents one physical node. This address is determined by the system designer, then configured in the terminal by entering the Node Address (**0** to **63**). The default address is **63**.

Data Rate – F4.4.1.9

In the Data Rate menu, select the desired data rate from these options:

125 Kb (the default) [0] 250 Kb [1] 500 Kb [1]

Data Format – F4.4.2

Provides access to the Format and Byte Order parameters.

Format – F4.4.2.1

From this menu, select a data format for the DeviceNet network. Options are **Division** [0], **Floating Point** [1] and **Integer** [2] (the default).

Byte Order – F4.4.2.2

This parameter selects the order in which the data bytes and words will be presented in the PLC data format. The choices are **Byte Swap [0]**, **Standard [1]**, **Word Swap [2]** (the default) and **Double Word Swap [3]**.

- **Byte Swap** makes the floating point format compatible with S7 PROFIBUS.
- **Standard** makes the floating point format compatible with PLC 5.
- **Word Swap** takes the IEE 754 single-precision floating point format and swaps the two words in the 32-bit double word. This format is compatible with RSLogix 5000 processors.
- **Double Word Swap** takes the IEE 754 single-precision floating point format and swaps the two words plus byte swaps in the 32-bit double word. This format makes floating point data compatible with Modicon Quantum processors.

A-B RIO – F4.4.1

This block is used to configure the A-B RIO interface option and data format. The two branches in this group are A-B RIO and Data Forma.

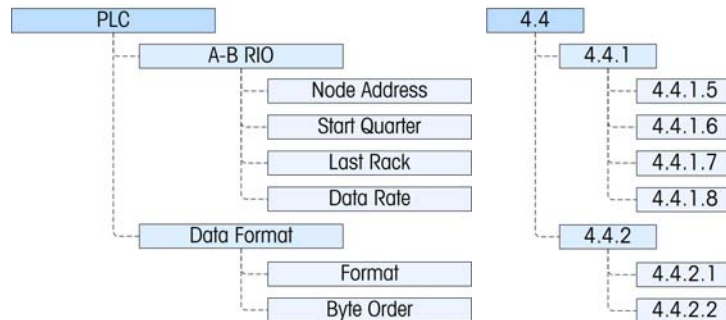

Figure 3-13: Setup Menu for A-B RIO

Additional interface information and programming examples can be found in the IND131/IND331 Terminal PLC Interface Manual, which is included on the documentation CD.

A-B RIO – F4.4.1

Provides access to address, rack position and data rate.

Node Address – F4.4.1.5

Each IND131 or IND331 Terminal connected to the network represents one physical node; however, the addressing of the node is defined as a logical rack address. This address is determined by the system designer, then configured in the terminal by accessing the Node Address menu and entering the appropriate node address, from **0** to **62**. The address entered in the IND131/331 terminal is decimal, while the address entered in the PLC is octal.

Start Quarter – F4.4.1.6

The block of data communicated from the terminal occupies a quarter rack (single group) in the RIO address space and the quarter (group) may be defined as the first (group 0) [1], second (group 2) [2], third (group 4) [3], or fourth (group 6) [4] quarter (group) of a rack. Designate the location to be used in a logical rack by selecting the appropriate start quarter address, from 1 to 4 (group 0–6), from the list.

Last Rack – F4.4.1.7

From the list, select **Disabled [0]** (the default) or **Enabled [1]** for last rack designation.

Data Rate – F4.4.1.8

In the Data Rate menu, select the desired data rate from these options:

57,600 [0] (default) 115,200 [1] 230,400 [2]

Data Format – F4.4.2

Provides access to the Format and Byte Order parameters.

Format – F4.4.2.1

The Format menu allows a data format to be selected from a list. Options are **Division [0]**, **Floating Point [1]** and **Integer [2]** (the default).

Byte Order – F4.4.2.2

This parameter selects the order in which the data bytes and words will be presented in the PLC data format. The choices are **Byte Swap [0]**, **Historic [1]** (the default) and **Word Swap [2]**.

- **Byte Swap** makes the floating point format compatible with S7 PROFIBUS.
- **Historic** makes the floating point format compatible with PLC 5.
- **Word Swap** takes the IEE 754 single-precision floating point format and swaps the two words in the 32-bit double word. This format is compatible with RSLogix 5000 processors.

Analog Output – F4.4.1

This block is used to configure the 4-20mA Analog Output interface option and data format. The branches in this group are Source, Zero Value, Full Scale Value and Calibrate Output.

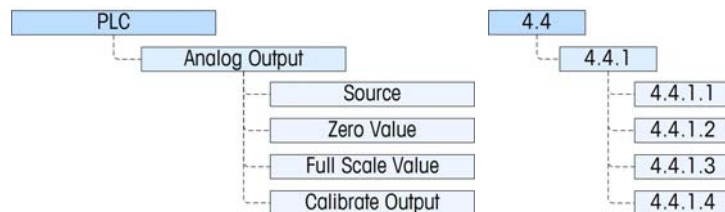

Figure 3-14: Setup Menu for Analog Output

Additional interface information can be found in the IND131/IND331 Terminal PLC Interface Manual, which is included on the documentation CD.

Source – F4.4.1.1

The IND131/331 analog output option provides a 4 - 20 mA output signal which can represent either the weight or the rate. In the Source selection menu, select the output source as **None [0]** (the default), **Displayed Weight [1]**, **Gross Weight [2]**, or **Rate [3]**.

Zero Value – F4.4.1.2

The Zero Value menu allows a numeric entry to be made, setting the displayed value equivalent for the analog output's 4mA (zero) level. For a standard weighing application, this would be **00000** reflecting zero weight on the scale.

Full Scale Value – F4.4.1.3

The Full Scale Value menu allows a numeric entry to be made, setting the displayed value equivalent for the analog output's 20mA (full scale) level. For a standard weighing application, this would be the capacity of the scale.

Calibrate Output – F4.4.1.4

Pressing the PRINT key at the **Calibrate Output** menu initiates a calibration routine that allows correlation of the zero and full scale analog output points of the terminal to what the connected device is expecting. The procedure follows these steps:

1. First, a message is shown **WARNING! Analog Output will change** indicating that the analog output will be controlled by the terminal for calibration purposes and will not represent the weight or rate as normal.
2. After accepting this message by pressing PRINT, a second message appears – **Signal now 4mA. Adjust then ENTER**. Use the TARE key to increase the analog signal or the CLEAR key to decrease the analog output signal to fine tune the output for the 4mA (zero) reference. Press ENTER when done.
3. The message **WARNING! Analog Output will change** is shown again indicating the analog output will change and is not related to the source value. Press PRINT to accept the message.
4. The next message is **Signal now 20mA. Adjust then ENTER**. Press the PRINT key to continue.
5. Use the TARE key to increase the analog signal or the CLEAR key to decrease the analog output signal to fine tune the output for the 20mA (full scale) reference. Press PRINT when done.

Reset – F4.5

The **Reset** menu enables the Communication setup block of values to be reset to factory default settings. To initiate a reset, press the PRINT key. A confirmation message appears, reading "WARNING Reset Communication?" Either press PRINT again to confirm the action, or ZERO to return to the **Communication** menu without resetting the values.

After a reset attempt, a status message of “Reset Successful” or “Reset Failed” will be shown indicating the status of the reset. Press PRINT to clear the message and return to the Reset menu branch.

Maintenance – F5

The maintenance menus include:

- Scale Diagnostics
- Serial Test
- Discrete I/O Test
- Reset All

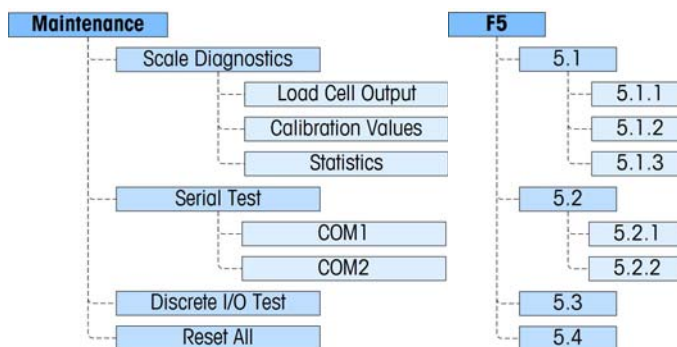

Figure 3-15: Maintenance Branch of Setup

Scale Diagnostics – F5.1

Provides access to its three sub-menus, **Load Cell Output**, **Calibration Values** and **Statistics**.

Load Cell Output – F5.1.1

The **Load Cell Output** menu is a live display that shows the current output of the load cell circuit, in engineering units.

Calibration Values – F5.1.2

This menu item accesses a sequence of three sub-menus (five sub-menus if Linearity is enabled) where parameters associated with calibration can be viewed or entered (if transferring calibration from another IND131 or IND331 terminal).

Zero Counts – F5.1.2.1

The **Zero Counts** menu shows the number of engineering units or “counts” that equate to gross zero on the display. The zero count value is automatically determined when the scale is calibrated. This value can be edited allowing the calibration values of one terminal to be transferred to another terminal.

- ◀ If this value is changed, the zero reference point will be shifted thus affecting the accuracy of the weighing system. DO NOT CHANGE THIS VALUE UNLESS YOU ARE TRANSFERRING ALL CALIBRATION VALUES FROM ANOTHER TERMINAL.

Test Load 1 – F5.1.2.2

This menu displays the value set during span calibration for calibration Test Load 1. With linearity disabled, this will be the full span test load. With linearity enabled, this will be the mid-point test load.

- ◀ If this value is changed, the test load used by the terminal to determine span will be shifted thus affecting the accuracy of the weighing system. DO NOT CHANGE THIS VALUE UNLESS YOU ARE TRANSFERRING ALL CALIBRATION VALUES FROM ANOTHER TERMINAL.

Test Load 1 counts – F5.1.2.3

This menu displays the “counts” that are associated with the **Test Load 1** value. The counts are automatically determined when the scale is calibrated. This value can be edited allowing the calibration values of one terminal to be transferred to another terminal.

- ◀ If this value is changed, the span counts will be changed thus affecting the accuracy of the weighing system. DO NOT CHANGE THIS VALUE UNLESS YOU ARE TRANSFERRING ALL CALIBRATION VALUES FROM ANOTHER TERMINAL.

If Linearity is enabled, pressing the PRINT key here moves to the **Test Load 2** menu; otherwise, the view returns to the **Zero Counts** menu.

Test Load 2 [if Linearity enabled] – F5.1.2.4

This menu displays the value set during span calibration for calibration Test Load 2. This will be the full span test load when linearity has been enabled.

Test Load 2 Counts [if Linearity enabled] – F5.1.2.5

This menu displays the “counts” that are associated with the **Test Load 2** value. The counts are automatically determined when the scale is calibrated. This value can be edited allowing the calibration values of one terminal to be transferred to another terminal.

- ◀ If this value is changed, the span counts will be changed thus affecting the accuracy of the weighing system. DO NOT CHANGE THIS VALUE UNLESS YOU ARE TRANSFERRING ALL CALIBRATION VALUES FROM ANOTHER TERMINAL.

Statistics – F5.1.3

Accesses a sequence of five menus that display statistics accumulated for the scale since the last Master Reset was performed. The following menus appear in sequence. Press the PRINT key to step through them.

Weighments	F5.1.3.1	The number of weighments that have been performed using the terminal. A weighment is determined when the PRINT key is pressed.
Overloads	F5.1.3.2	The number of scale over capacities encountered.
Peak Weight	F5.1.3.3	The heaviest weight that has been applied to the scale.
Zero Commands	F5.1.3.4	The number of pushbutton Zero commands issued.

Zero Failures **F5.1.3.5** The number of times the scale failed to achieve Zero when a zero command was issued.

Serial Test – F5.2

Provides access to COM1 and COM2 serial port test routines.

COM1 – F5.2.1

Accesses the display screen for testing of COM1. The display will appear similar to the one shown in Figure 3-16:



Figure 3-16: Serial Test Display

During this test, the serial port will transmit the string shown in the upper line approximately every two seconds. The two digits at the end of the transmit string "Testing COM1 xx" will increment from 01 to 99 at each transmission then start over again.

If a simple loop-back jumper is inserted onto the COM1 port during this test, the data that is transmitted (as shown on the upper line) will also be displayed on the lower line as data received.

COM2 – F5.2.2

The COM2 serial port test is performed as described previously for COM1.

Discrete I/O Test – F5.3

This menu provides access to a test routine where the outputs can be turned "ON" or "OFF" by key strokes and the status of the two inputs are indicated as "OFF" or "ON".

WARNING!

BEFORE PERFORMING THE DISCRETE I/O TEST, ALWAYS REMOVE CONTROL POWER FROM ALL ATTACHED CONTROLS. FAILURE TO DO SO CAN RESULT IN INJURY AND/OR EQUIPMENT DAMAGE.

When first accessed, a message will appear – **WARNING! REMOVE CONTROL POWER**. Either remove control power and press the PRINT key to proceed to the next step, or press the ZERO key to return to the **Discrete I/O Test** menu.

A two-line display will appear as shown in Figure 3-17. To terminate the Discrete I/O test, press the PRINT key. The view will return to the **Discrete I/O Test** menu. Refer to the details of operating the DIO diagnostic screen in Chapter 4.0, **Service and Maintenance**.



Figure 3-17: Discrete I/O Test Display, Output Active (bottom)

Reset All – F5.4

The **Reset All** menu triggers the Reset function in each branch of the menu tree and restores the associated parameters to their factory default settings.

To initiate a reset, press the PRINT key. A confirmation message appears, reading **WARNING Reset all?** Either press PRINT again to confirm the action, or ZERO to return to the **Maintenance** menu without resetting the values.

After a reset attempt, a status message of “**Reset Successful**” or “**Reset Failed**” will be shown indicating the status of the reset. Press PRINT to clear the message and return to the Reset menu branch.

- The Reset All step resets all parameters in the terminal, excluding calibration and the other associated metrological parameters.

Restoring Factory Default Settings

Factory default settings can be restored individually for branches such as Scale, Application, Terminal, and Communication or a reset of all of these branches can be done with the Reset All screen under the Maintenance branch. The Reset screen is the last branch in each major branch of the menu tree. Note that calibration and other metrological parameters related to the calibration are not reset. To reset the calibration parameters, a Master Reset must be performed.

To restore factory default settings for Terminal, for example:

1. In setup, navigate to the Terminal branch.
2. Press PRINT to open the Terminal branch and view the sub-menus.
3. Press CLEAR to navigate down to the Reset menu.
4. Press PRINT to open the Terminal Reset screen.
5. A warning message of “WARNING! Reset Terminal?” is shown.
6. Press PRINT to perform the reset or ZERO to escape without a reset.
7. A status message appears that verifies a successful reset.
8. Press the ZERO key to return to the setup menu tree display.

Steps 1–8 can be repeated to reset factory default settings for any major branch in setup.

- Select Reset All under Maintenance to restore all setup settings to factory defaults. Note that neither this, nor Scale Reset, includes the reset of capacity, increment, or calibration data. This data is reset only with a Master Reset.

Chapter 4.0

Service and Maintenance

This chapter covers

- Cleaning and Maintenance
- Service
- Troubleshooting
- System Backup and Restore
- Master Reset

The IND131 and IND331 terminals are designed to provide years of dependable operation. However, METTLER TOLEDO recommends that – as with any industrial measurement equipment – the terminal and the connected scale system be serviced periodically. Timely, factory-specified maintenance and calibration by a METTLER TOLEDO service technician will ensure and document accurate and dependable performance to specifications.

Cleaning and Maintenance



Clean the terminal's keypad and cover with a clean, soft cloth that has been dampened with a mild glass cleaner. Do not use any type of industrial solvent such as toluene or isopropanol (IPA) that could damage the terminal's finish. Do not spray cleaner directly on the terminal.

Regular maintenance inspections and calibration by a qualified service technician are recommended. The IND131 and IND331 terminals are rugged instruments; however, the front panel is a relatively thin covering over sensitive electronic switches and a lighted display. Care should be taken to avoid any punctures to this surface or any vibrations or shocks to the instrument. Should the front panel become punctured, ensure that steps are taken to prevent dust and moisture from entering the unit until the terminal can be repaired.

Service

Only qualified personnel should perform installation, programming, and service. Please contact a local METTLER TOLEDO representative for assistance.

METTLER TOLEDO recommends periodic preventative maintenance to the terminal and scale system to ensure reliability and to maximize service life. All measurement systems should be periodically calibrated and certified as required to meet production, industry and regulatory requirements. We can help you maintain uptime, compliance and quality system documentation with periodic maintenance and calibration services. Contact your local METTLER TOLEDO authorized service organization to discuss your requirements

	 WARNING
	ONLY PERMIT QUALIFIED PERSONNEL TO SERVICE THE TERMINAL. EXERCISE CARE WHEN MAKING CHECKS, TESTS AND ADJUSTMENTS THAT MUST BE MADE WITH POWER ON. FAILING TO OBSERVE THESE PRECAUTIONS CAN RESULT IN BODILY HARM AND/OR PROPERTY DAMAGE.

Troubleshooting

Troubleshooting activities described here are limited to simple diagnostics to assist in identifying whether the problem is in the IND131/331 terminal or has an external cause.

- Diagnostic LEDs
- Problems
- Error Codes and Error Messages
- Internal Diagnostic Testing

Diagnostic LEDs

Two red LEDs are positioned next to the COM1 serial port connector (Figure 4-1) that indicate the operational status of the load cell excitation circuit and the +5 volt logic voltage of the terminal. If an LED is ON, it indicates normal operation of that circuitry. If either LED is OFF during operation, it indicates a problem with that circuitry in the terminal. In this case, contact an authorized METTLER TOLEDO service representative for assistance.

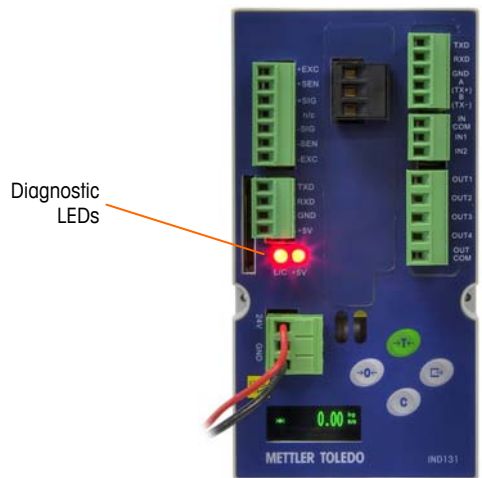

Figure 4-1: Diagnostic LEDs

Problems

The following chart lists a few potential symptoms and some suggestions for resolving the issue. Use qualified electricians to test for problems with the AC

power source. If a problem occurs but that specific problem is not listed in Table 4-1, or the suggested fix does not resolve the problem, contact an authorized METTLER TOLEDO service representative for assistance.

Table 4-1: Symptoms and Suggested Fixes

Symptom	Suggestion
Blank display – no LEDs	Confirm source of AC or DC power is OK.
Blank display – LEDs on	Possible problem with communication to the display PCB. Contact service representative.
Display on but no weight change	Check wiring to load cell. Look for broken wires, open connections or mis-wiring.
No serial port communications	Use serial diagnostics section of Maintenance block of setup to determine if the problem is internal or external to the terminal.
Discrete inputs or outputs don't operate.	Use the discrete input and output diagnostics section of the Maintenance block of setup to determine if the problem is internal or external to the terminal.

Error Codes and Error Messages

The IND131 and IND331 terminals use error codes and error messages to indicate error conditions that occur in the terminal. An example of an error code display is given in Figure 4-2.



Figure 4-2: Error Code Display

Error messages that occur as a result of an operator action will remain on the display until cleared by pressing PRINT. Error messages that result from a remote operation and not an operator action will clear automatically after approximately 3 seconds. In either case, after the message is cleared, the display reverts to the previous data shown before the error was detected. The possible error codes and messages are listed in Table 4-2 with a brief description of the error.

Table 4-2: Error Codes

Error Code	Description
0004	No factory calibration for A/D circuit.
0005	The function currently being accessed has been disabled.
0007	Access denied. Scale is approved.
0008	Data is out of range of valid entries.
0009	Zero failed – weight is beyond capture range.
0010	Comparator data entry error: High Limit value must be larger than Limit value.
0011	Command failed.
0012	Command failed – motion.
0013	Weight exceeds scale capacity. Exit the Step Calibration procedure.
0014	Invalid Password.
0015	Switch SW1-1 is unsecured. If the terminal is W&M approved, this switch must be ON before setup can be exited.
0016	New capacity results in resolution of less than 1,000 divisions or more than 100,000 divisions: Increment size has been changed automatically.
0017	PLC node address is outside allowed range.
0018	Existing calibration weight exceeds new capacity; recalibrate scale with valid test weight.

Internal Diagnostics

The IND131 and IND331 terminals provide several internal diagnostic tools that are accessible in setup mode. These tests are intended to assist in diagnosing whether a problem is internal or external to the terminal.

To access these tools, enter SETUP mode and navigate to the Maintenance menu. Open the Maintenance branch. Each of the diagnostic items is shown in the menu. The following diagnostic tests are included:

Scale Diagnostics

- **Load Cell Output** — Displays the current load cell output (active weight) in internal counts. When weight is placed on the scale platform, the number of counts should increase.
- **Calibration Values** — Displays the current calibration values for the scale. If these values are recorded after a scale calibration, and the Main PCB is replaced in the future, the calibration values can be manually entered here to “transfer” the previous calibration to the new Main PCB.
- **Statistics** — Displays statistical information for the scale such as the total number of weighments (as determined by a demand print), the number of scale overloads, the peak weight weighed on the scale, total number of zero commands and failed zero commands. This data can be very helpful when diagnosing scale problems.

Serial Test

This tool tests the transmit and receive functions on the serial (COM) ports. The COM port to be tested must be selected first and then the test can be started.

1. With the desired COM port in focus, press PRINT to begin the test.



Figure 4-3: Serial Test Display

2. During the test, a data string is output repeatedly approximately once every three seconds. The data is: [Testing COMx: nn] where "x" is the COM port and "nn" is an incrementing value beginning at 1 and continuing through 99 then starting over again. Each transmission increments this number by one.
3. Any data received during the serial test is displayed in the bottom part of the display to the right of the "Rx:" label. Control characters are not displayed in this mode.
4. If a jumper wire is placed between the transmit and the receive terminals (Figure 4-4) on the port being tested, the same data string that is transmitted displays as the receiving field. This jumper can confirm correct operation of both the transmit and receive circuitry of that COM port.



Figure 4-4: Jumper Wire Between COM Transmit and Receive Terminals

5. To stop the serial port test, press the PRINT key.

Discrete I/O Test

This test provides a view of the status of the discrete inputs and allows enabling or disabling of the discrete outputs for diagnostic purposes. Expand the Discrete I/O branch by pressing the PRINT key.

1. A warning message is shown first to remind the tester that the outputs can be turned on manually during this test so any control power to the discrete outputs should be removed.

	WARNING
	<p>THE DISCRETE OUTPUTS OF THE IND131 AND IND331 TERMINAL WILL BE MANUALLY ENABLED DURING THIS TEST. REMOVE OUTPUT CONTROL POWER SO EXTERNAL EQUIPMENT WILL NOT BE ENERGIZED BY MISTAKE. EXERCISE CARE WHEN MAKING CHECKS, TESTS AND ADJUSTMENTS THAT MUST BE MADE WITH POWER ON. FAILURE TO OBSERVE THESE PRECAUTIONS CAN RESULT IN BODILY HARM AND/OR PROPERTY DAMAGE.</p>

- Press PRINT to continue to the diagnostic screen. When viewing the test screen, the input status will be shown at the top of the display and the output status will be shown at the bottom of the display (Figure 4-5). Focus is shown on Output #4 (far right) first.

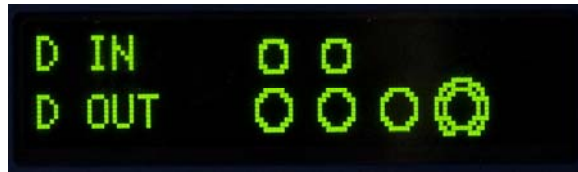

Figure 4-5: Discrete I/O Test Screen

- Focus for control of a specific output is indicated by a large circle around the outside of the smaller circle. When an output is in focus, pressing the TARE key turns the output ON. The smaller circle becomes solid to indicate that output is ON ●. This is shown in Figure 4-6.



Figure 4-6: Discrete I/O Test Screen, One Output Active

- Pressing the CLEAR key returns the output in focus to the OFF condition and the circle is shown as empty ○.
- Focus can be moved to any of the other outputs by using the ZERO key to move one position to the left. Each of the outputs can then be turned ON with the TARE key or OFF with the CLEAR key.
- To end the test and exit, press the PRINT key.

Note that when the Discrete I/O Test screen is exited, all outputs will be turned off again.

System Backup and Restore

An optional SD memory card is available for the IND131 and IND331 terminal. The card provides a medium to store a setup file containing the terminal's configuration. All setup parameters are saved in a file that can be restored to the terminal in case the data is lost or after the setup is totally cleared with a master reset.

The SD memory card supports saving of as many as 99 setup files. The backup and restore process provides the ability to name the backup file with a value from 01 to 99, and permits the selection of a particular file to restore.

The terminal will initiate the backup and restore sequence of prompts when the terminal detects at power up that an SD memory card is present **when it was not present the previous time the terminal was powered on**.

The SD memory card is not hot-swappable.

- The SD memory media provided by METTLER TOLEDO as an option has been fully tested for correct operation. While other SD memory media may work, some may not work correctly. METTLER TOLEDO will only support correct operation of the SD memory card model offered as the IND131 and IND331 terminal accessory.

Backup

With the terminal unplugged from power, insert the SD memory into the slot as shown in Figure 4-7 or Figure 4-8. Note that it is inserted upside down from the normal orientation. Do not force the card into the slot. If the card does not slide smoothly into the slot, confirm the correct orientation.



Figure 4-7: SD Memory Card Insertion, DIN Terminal

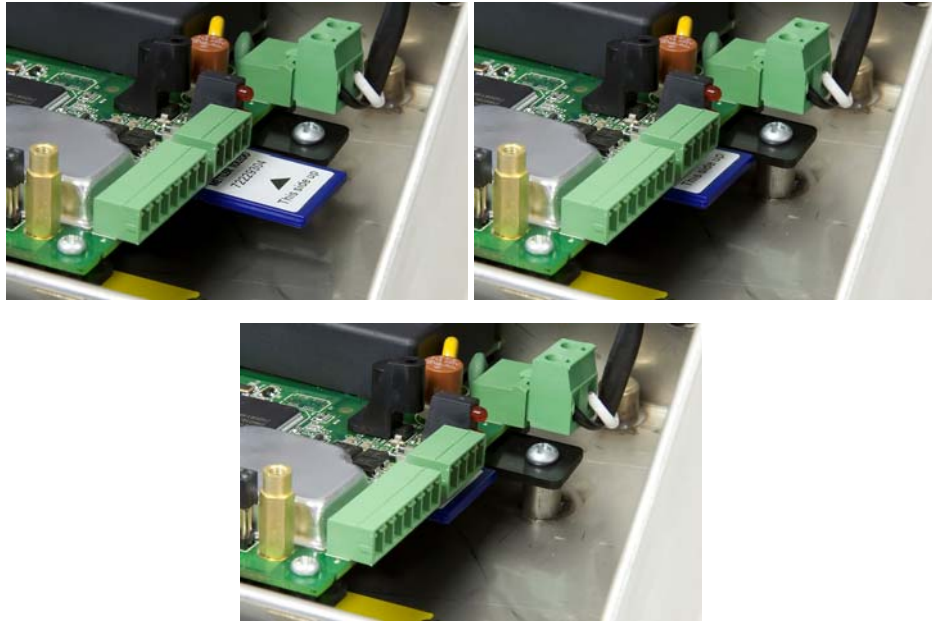

Figure 4-8: SD Memory Card Insertion, IND331 in Harsh Enclosure

When power is applied to the terminal, the SD memory card will be recognized and a series of prompts will be shown on the display. Follow the prompts to perform the backup function.

The sequence of prompts for backing up or saving the setup is shown in Table 4-3.

Table 4-3: Backup Sequence

Step	Display	Notes
1	Save setup file? No	TARE or CLEAR key to change "No" to "Yes" then press PRINT.
2	File Name? File_01	Increment the number for the file name using the TARE and CLEAR keys then press PRINT.
3	Save complete.	File was successfully written to the SD memory. Acknowledge by pressing PRINT.
4	>0< 0.00 kg B/G	After the sequence is complete the display returns to the normal weight display.



Restore

With the terminal unplugged from power, insert the SD memory into the slot as shown in Figure 4-7 or Figure 4-8. Note that it is inserted upside down from the normal orientation. Do not force the card into the slot. If the card does not slide smoothly into the slot, confirm the correct orientation.

When power is applied to the terminal, the SD memory card will be recognized and a series of prompts will be shown on the display. Follow the prompts to perform the restore function.

The sequence of prompts is shown in Table 4-4.

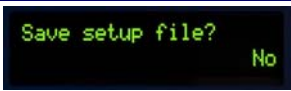
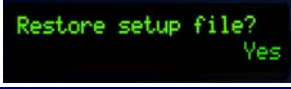
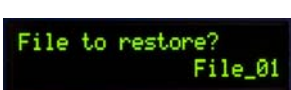
Table 4-4: Restore Sequence

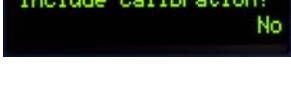
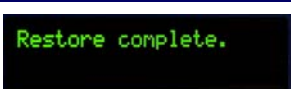
Step	Display	Notes
1		Press PRINT with "No" as the selection for Save Setup File.
2		TARE or CLEAR key to change "No" to "Yes" then press PRINT.
3		Scroll through the list of available stored files using the TARE and CLEAR keys until the desired file is shown then press PRINT.
4		If calibration values from the stored file are not to be used in the new terminal, press PRINT with "No" displayed. If calibration is to be transferred, press TARE to change "No" to "Yes" then press PRINT.
5		The selected file was successfully uploaded from the SD memory to the terminal. Acknowledge by pressing PRINT.
6		After the sequence is complete the display returns to the normal weight display.

Default Settings

Setup Defaults

The following table lists the factory default settings for the setup parameters of the IND131 and IND331 terminals. Both the Name and the F-Code for each parameter are listed. The default value when viewing the setup programmed for F-Codes is shown in parenthesis immediately after the F-Code number. A column is provided to note how each parameter has been programmed for this specific terminal.

Setup Feature	F-Code	Default Value	As Programmed
Scale – Type			
Name	1.1.1	Scale 1	
Approval	1.1.2 (0)	None	
Scale – Capacity and Increment			
Units	1.2.1 (2)	kg	
Capacity	1.2.2	50	
Increment	1.2.3 (3)	0.01	
x10 Always	1.2.4 (0)	Disabled	
Scale – Calibration			
Linearity	1.3.1 (0)	Disabled	
Scale – Zero			
Auto Zero	1.4.1 (1)	Gross	
Auto Zero Range	1.4.2 (0)	0.5 d	
Under Zero Blanking	1.4.3 (1)	5d	
Pushbutton Zero	1.4.4 (1)	+/- 2%	
Scale – Tare			
Pushbutton Tare	1.5.1 (1)	Enabled	
Net Sign Correction	1.5.2 (0)	Disabled	
Scale – Rate			
Weight Units	1.6.1 (0)	None	
Time Units	1.6.2 (0)	Seconds	
Measurement Period	1.6.3 (1)	1 sec	

IND131/IND331 Terminals User's Guide

Setup Feature	F-Code	Default Value	As Programmed
Output Average	1.6.4 (0)	1 sec	
Scale – Filter			
Low Pass Filter	1.7.1 (1)	Medium	
Stability Filter	1.7.2 (0)	Disabled	
Scale – Stability			
Motion Range	1.8.1 (1)	1d	
Scale – Log or Print			
Auto Print	1.9.1 (0)	Disabled	
Application – Target Operation			
Tolerance Type	2.1.1 (0)	Weight Deviation	
Output Type	2.1.2 (0)	Concurrent	
Target Source	2.1.3 (0)	Displayed Weight	
Target Latching	2.1.4 (1)	Enabled	
Application – Target Values			
Target	2.2.1	0.00 kg	
- Tol	2.2.2	0.00 kg	
+ Tol	2.2.3	0.00 kg	
Spill	2.2.4	0.00 kg	
Fine Feed	2.2.5	0.00 kg	
Application – Comparator 1			
Comparator 1 Source	2.3.1 (0)	Disabled	
Comparator 1 Active	2.3.2 (0)	<	
Limit 1	2.3.3	0.00 kg	
High Limit 1	2.3.4	0.00 kg	
Application – Comparator 2			
Comparator 2 Source	2.3.5 (0)	Disabled	
Comparator 2 Active	2.3.6 (0)	<	
Limit 2	2.3.7	0.00 kg	
High Limit 2	2.3.8	0.00 kg	
Application – Comparator 3			
Comparator 3 Source	2.3.9 (0)	Disabled	
Comparator 3 Active	2.3.10 (0)	<	
Limit 3	2.3.11	0.00 kg	
High Limit 3	2.3.12	0.00 kg	

Setup Feature	F-Code	Default Value	As Programmed
Application – Discrete I/O – Discrete Inputs			
Input 1 Polarity	2.4.1.1 (0)	+ True	
Input 1 Assignment	2.4.1.2 (0)	None	
Input 2 Polarity	2.4.1.3 (0)	+ True	
Input 2 Assignment	2.4.1.4 (0)	None	
Application – Discrete I/O – Discrete Outputs			
Output 1 Assignment	2.4.2.1 (0)	None	
Output 2 Assignment	2.4.2.2 (0)	None	
Output 3 Assignment	2.4.2.3 (0)	None	
Output 4 Assignment	2.4.2.4 (0)	None	
Terminal – Set Serial Number			
Serial Number	3.1.1	00000000	
Terminal – Set Screen Saver			
Screen Saver	3.2.1 (3)	10 min	
Terminal – Region			
Menu Language	3.3.1 (0)	English	
Setup Language	3.3.2 (0)	English	
Terminal – User			
Password Protection	3.4.1 (0)	Disabled	
Password	3.4.2	000000	
Terminal – Menu Keys			
Calibration Access	3.5.1 (1)	Enabled	
Target Access	3.5.2 (0)	Disabled	
Comparators Access	3.5.3 (0)	Disabled	
Communication – Output Template			
Format	4.1.1 (2)	GTN, multiple lines	
Print Scale Name	4.1.2 (0)	Disabled	
Communication – Connections – COM1			
COM1 Assignment	4.2.1 (3)	Demand Output	
Checksum	4.2.1.1 (0)	Disabled	
Communication – Connections – COM2			
COM2 Assignment	4.2.2 (3)	None	
Checksum	4.2.2.1 (0)	Disabled	

Setup Feature	F-Code	Default Value	As Programmed
Communication – Serial – COM1			
Baud Rate	4.3.1.1 (5)	9600	
Data Bits	4.3.1.2 (1)	8	
Parity	4.3.1.3 (0)	None	
Communication – Serial – COM2			
Baud Rate	4.3.2.1 (5)	9600	
Data Bits	4.3.2.2 (1)	8	
Parity	4.3.2.3 (0)	None	
Interface	4.3.2.4 (0)	RS-232	
Communication – PLC – Analog Output [Shown when option is detected]			
Source	4.4.1.1 (0)	None	
Zero Value	4.4.1.2	0	
Full Scale Value	4.4.1.3	50	
Communication – PLC – A-B RIO [Shown when option is detected.]			
Node Address	4.4.1.5	001	
Start Quarter	4.4.1.6 (1)	1	
Last Rack	4.4.1.7 (0)	Disabled	
Data Rate	4.4.1.8 (0)	57600	
Communication – PLC – Data Format [Shown when option is detected.]			
Format	4.4.2.1 (2)	Integer	
Byte Order	4.4.2.2 (1)	Historic	
Communication – PLC – DeviceNet [Shown when option is detected.]			
Node Address	4.4.1.5	063	
Data Rate	4.4.1.9 (0)	125k	
Communication – PLC – Data Format [Shown when option is detected.]			
Format	4.4.2.1 (2)	Integer	
Byte Order	4.4.2.2 (2)	Word Swap	
Communication – PLC – PROFIBUS [Shown when option is detected.]			
Node Address	4.4.1.5	001	
Communication – PLC – Data Format [Shown when option is detected.]			
Format	4.4.2.1 (2)	Integer	
Byte Order	4.4.2.2 (0)	Byte Swap	

A-B RIO

DeviceNet

PROFIBUS

Ethernet/IP
Modbus TCP

Setup Feature	F-Code	Default Value	As Programmed
Communication – PLC – EtherNet/IP & Modbus TCP [Shown when option is detected.]			
DHCP Client	4.4.1.10 (0)	Disabled	
IP Address	4.4.1.11	192.168.000.001	
Subnet Mask	4.4.1.12	255.255.255.000	
Gateway Address	4.4.1.13	000.000.000.000	
Communication – PLC – Data Format [Shown when option is detected.]			
Format	4.4.2.1 (2)	Integer	
Byte Order	4.4.2.2 (2)	Word Swap	

Appendix B

Parameter Values

The following table lists each of the setup parameters shown when the Setup mode is programmed to display F-Codes instead of English. A descriptive name is included, followed by a list of the selections with corresponding selection values.

	F-Code	Descriptive Name	Selections and Values
F1 – Scale	F1.1	Type	
	F1.1.1	Name	xxxxxxx
	F1.1.2	Approval	0: None 1: USA 2: OIML 3: Canada
	F1.2	Capacity and Increment	
	F1.2.1	Units	0: None 1: g 2: kg 3: lb 4: t 5: ton
	F1.2.2	Capacity	xxxxxxx
	F1.2.3	Increment	0: 0.001 1: 0.002 2: 0.005 3: 0.01 4: 0.02 5: 0.05 6: 0.1 7: 0.2 8: 0.5 9: 1 10: 2 11: 5 12: 10 13: 20 14: 50 15: 100
	F1.2.4	x10 Always	0: Disabled 1: Enabled
	F1.3	Calibration	
	F1.3.1	Linearity	0: Disabled 1: Enabled
	F1.3.2	Set Zero	

F-Code	Descriptive Name	Selections and Values
F1.3.3	Set Span	
F1.3.4	Step Calibration	
F1.3.5	CalFREE	
F1.4	Zero	
F1.4.1	Auto Zero	0: Disabled 1: Gross 2: Gross and Net
F1.4.2	Auto Zero Range	0: 0.5d 1: 1d 2: 3d 3: 10d
F1.4.3	Under Zero Blanking	0: Disabled 1: 5d always
F1.4.4	Pushbutton Zero	0: Disabled 1: ±2% 2: ±20%
F1.5	Tare	
F1.5.1	Pushbutton Tare	0: Disabled
F1.5.2	Net Sign Correction	1: Enabled
F1.6	Rate	
F1.6.1	Weight Units	0: None 1: Primary
F1.6.2	Time Units	0: Seconds 1: Minutes 2: Hours
F1.6.3	Measurement Period	0: 0.5s 1: 1s 2: 5s
F1.6.4	Output Average	0: 1s 1: 5s 2: 10s 3: 30s 4: 60s
F1.7	Filter	
F1.7.1	Low Pass Filter	0: Light 1: Medium 2: Heavy
F1.7.2	Stability Filter	0: Disabled 1: Enabled
F1.8	Stability	
F1.8.1	Motion Range	0: Motion Detection Disabled 1: 1d 2: 3d
F1.9	Log or Print	
F1.9.1	Auto Print	0: Disabled 1: After Target
F1.10	Reset Scale	

F1 - Scale

F-Code	Descriptive Name	Selections and Values
F2.1	Target Operation	
F2.1.1	Tolerance Type	0: Weight Deviation 1: % of Target
F2.1.2	Output Type	0: Concurrent 1: Independent
F2.1.3	Target Source	0: Displayed weight 1: Gross weight
F2.1.4	Target Latching	0: Disabled 1: Enabled
F2.2	Target Values	
F2.2.1	Target	xxxxxxxx
F2.2.2	- Tolerance	xxxxxxxx
F2.2.3	+ Tolerance	xxxxxxxx
F2.2.4	Spill	xxxxxxxx
F2.2.5	Fine Feed	xxxxxxxx
F2.3	Comparators	
F2.3.1	Comparator 1 Source	0: Disabled 1: Displayed Weight 2: Gross Weight 3: Rate
F2.3.2	Comparator 1 Active	0: < (less than) 1: <= (less than or equal to) 2: = (equal to) 3: > (greater than) 4: >= (greater than or equal to) 5: <> (not equal to) 6: _< >_ (outside range) 7: >_< (inside range)
F2.3.3	Comparator 1 Limit	xxxxxxxx
F2.3.4	Comp. 1 High Limit	xxxxxxxx
F2.3.5	Comparator 2 Source	0: Disabled 1: Displayed Weight 2: Gross Weight 3: Rate
F2.3.6	Comparator 2 Active	0: < (less than) 1: <= (less than or equal to) 2: = (equal to) 3: > (greater than) 4: >= (greater than or equal to) 5: <> (not equal to) 6: _< >_ (outside range) 7: >_< (inside range)
F2.3.7	Comparator 2 Limit	xxxxxxxx
F2.3.8	Comp. 2 High Limit	xxxxxxxx

F2 – Application

	F-Code	Descriptive Name	Selections and Values
F2 - Application	F2.3.9	Comparator 3 Source	0: Disabled 1: Displayed Weight 2: Gross Weight 3: Rate
	F2.3.10	Comparator 3 Active	0: < (less than) 1: <= (less than or equal to) 2: = (equal to) 3: > (greater than) 4: >= (greater than or equal to) 5: <> (not equal to) 6: _< >_ (outside range) 7: >_< (inside range)
	F2.3.11	Comparator 3 Limit	xxxxxxxx
	F2.3.12	Comp. 3 High Limit	xxxxxxxx
	F2.4	Discrete I/O	
	F2.4.1	Discrete Inputs	
	F2.4.1.1	Input 1 Polarity	0: + True 1: - True
	F2.4.1.2	Input 1 Assignment	0: None 1: Clear Tare 2: Keypad disabled 3: Print 4: Tare 5: Target abort 6: Target start 7: Zero
	F2.4.1.3	Input 2 Polarity	0: + True 1: - True
	F2.4.1.4	Input 2 Assignment	0: None 1: Clear Tare 2: Keypad disabled 3: Print 4: Tare 5: Target abort 6: Target start 7: Zero
	F2.4.2	Discrete Outputs	
	F2.4.2.1	Output 1 Assignment	0: None 1: Center of Zero 2: Comparator 1 3: Comparator 2 4: Comparator 3 5: Fast Feed 6: Feed 7: In Tolerance 8: Motion 9: Net 10: Over capacity 11: Under Zero
	F2.4.2.2	Output 2 Assignment	
	F2.4.2.3	Output 3 Assignment	
	F2.4.2.4	Output 4 Assignment	
	F2.5	Reset Application	

	F-Code	Descriptive Name	Selections and Values
F3 – Terminal	F3.1	Serial Number	
	F3.1.1	Serial Number	xxxxxxxx
	F3.2	Screen Saver	
	F3.2.1	Screen Saver	0: Disabled 1: 1 minute 2: 5 minutes 3: 10 minutes
	F3.3	Region	
	F3.3.1	Menu Language	0: English 1: "F" code 2: French 3: German 4: Italian 5: Spanish
	F3.3.2	Setup Language	0: English 1: "F" codes
	F3.4	User	
	F3.4.1	Password Protection	0: Disabled 1: Enabled
	F3.4.2	Password	xxxxxx
	F3.5	Menu Keys	
	F3.5.1	Calibration Access	0: Disabled 1: Enabled
	F3.5.2	Target Access	
	F3.5.3	Comparator Access	
	F3.6	Rest Terminal	
	F4 – Communication	F4.1	Output Template
F4.1.1		Format	0: Displayed Weight Only 1: G-T-N single line 2: G-T-N multiple lines
F4.1.2		Print Scale Name	0: Disabled 1: Enabled
F4.2		Connections	
F4.2.1		COM1 Assignment	0 – None 1 – Continuous Output 2 – Continuous-Extended Output 3 – Demand Output 4 – SICS 5 – Variable Access
F4.2.1.1		COM1 Checksum	0: Disabled 1: Enabled
F4.2.2		COM2 Assignment	0 – None 1 – Continuous Output 2 – Continuous-Extended Output 3 – Demand Output 4 – SICS
F4.2.2.1		COM2 Checksum	0: Disabled 1: Enabled

F-Code	Descriptive Name	Selections and Values
F4.3	Serial	
F4.3.1	COM1	
F4.3.1.1	COM1 Baud Rate	0: 300 1: 600 2: 1200 3: 2400 4: 4800 5: 9600 6: 19200 7: 38400 8: 57600 9: 115200
F4.3.1.2	COM1 Data Bits	0: 7 1: 8
F4.3.1.3	COM1 Parity	0: None 1: Even 2: Odd
F4.3.2	COM2	
F4.3.2.1	COM2 Baud Rate	0: 300 1: 600 2: 1200 3: 2400 4: 4800 5: 9600 6: 19200 7: 38400 8: 57600 9: 115200
F4.3.2.2	COM2 Data Bits	0: 7 1: 8
F4.3.2.3	COM2 Parity	0: None 1: Even 2: Odd
F4.3.2.4	COM2 Interface	0: RS232 1: RS485
F4.4.0	PLC Type	
	PLC Type	0: None 2: PROFIBUS 3: Eth/IP or Modbus TCP 4: DeviceNet 5: A-B RIO 6: Analog Output
F4.4.1	PLC – Analog Output	
F4.4.1.1	Source	0: None 1: Displayed Weight 2: Gross Weight 3: Rate
F4.4.1.2	Zero Value	xxxxxxx
F4.4.1.3	Full Span Value	xxxxxxx

F4 - Communication

F-Code	Descriptive Name	Selections and Values
F4.4.1.4	Calibrate Output	
F4.4.1	PLC – A-B RIO	
F4.4.1.5	Node Address	xxx
F4.4.1.6	Start Quarter	1: 1 2: 2 3: 3 4: 4
F4.4.1.7	Last Rack	0: Disabled 1: Enabled
F4.4.1.8	Data Rate	0: 57600 1: 115200 2: 230400
F4.4.2	Data Format – A-B RIO	
F4.4.2.1	Format	0: Division 1: Floating Point 2: Integer
F4.4.2.2	Byte Order	0: Byte swap 1: Historic 2: Word swap
F4.4.1	PLC - PROFIBUS	
F4.4.1.5	Node Address	xxx
F4.4.2	Data Format – PROFIBUS	
F4.4.2.1	Format	0: Division 1: Floating Point 2: Integer
F4.4.2.2	Byte Order	0: Byte swap 1: Standard 2: Word swap 3: Double Word swap
F4.4.1	PLC – DeviceNet	
F4.4.1.5	Node Address	xxx
F4.4.1.9	Data Rate	0: 125K 1: 250K 2: 500K
F4.4.2	Data Format – DeviceNet	
F4.4.2.1	Format	0: Division 1: Floating Point 2: Integer
F4.4.2.2	Byte Order	0: Byte swap 1: Standard 2: Word swap 3: Double Word swap
F4.4.1	PLC – Eth/IP, Modbus TCP	
F4.4.1.10	DHCP Client	0: Disabled 1: Enabled
F4.4.1.11	IP Address	
F4.4.1.12	Subnet Mask	

F4 - Communication

	F-Code	Descriptive Name	Selections and Values
	F4.4.1.13	Gateway	
	F4.4.2	Data Format – Eth/IP, Modbus TCP	
	F4.4.2.1	Format	0: Division 1: Floating Point 2: Integer
	F4.4.2.2	Byte Order	0: Byte swap 1: Standard 2: Word swap 3: Double Word swap
	F4.5	Reset Communication	
F5 - Maintenance	F5.1	Scale Diagnostics	
	F5.1.1	Load Cell Output	123456
	F5.1.2	Calibration Values	
	F5.1.2.1	Zero Counts	xxxxxxx
	F5.1.2.2	Test Load 1	xxxxxxx
	F5.1.2.3	Test Load 1 Counts	xxxxxxx
	F5.1.2.4	Test Load 2	xxxxxxx
	F5.1.2.5	Test Load 2 Counts	xxxxxxx
	F5.1.3	Statistics	
	F5.1.3.1	Weighments	xxxxxxx
	F5.1.3.2	Overloads	xxxxxxx
	F5.1.3.3	Peak Weight	xxxxxxx
	F5.1.3.4	Zero Commands	xxxxxxx
	F5.1.3.5	Zero Failures	xxxxxxx
	F5.2	Serial Test	
	F5.2.1	Test COM 1	
	F5.2.2	Test COM 2	
	F5.3	Discrete I/O Test	
F5.4	Reset All		

Communications

Serial Interface Parameters

This Appendix covers

- Serial Interface Parameters
- Demand Output Mode
- Continuous Output Mode
- Extended Continuous Output Mode
- CTPZ
- SICS Protocol
- Variable Access

One standard serial port and one optional serial port are supported with the IND131 and IND331 terminals. They are designated COM1 (standard port on the Main PCB) and COM2 (optional).

COM1 provides an RS-232 interface only. The RS-232 interface is a three-wire (TDX, RXD, and GND) with no handshaking. There is also a 5 volt DC supply available on this port.

Optional **COM2** provides RS-232 and RS-485 interfaces. The RS-232 interface is a three-wire (TDX, RXD, and GND) with no handshaking. The RS-485 connection is a two-wire interface but does not support multi-drop communication with addressing. The port must be selected for use as either RS-232 or RS-485 due to the

different operating requirements of the interfaces.

Character framing is programmable in the setup mode. Framing can be:

- 1 start bit
- 7 or 8 ASCII data bits (selectable)
- 0 or 1 parity bit (none, even, or odd)
- 1 stop bit

The baud rate can be configured from 300 to 115.2K baud and a checksum character can also be configured when using one of the continuous output strings.

The IND131 and IND331 terminals support the following functions on the serial ports:

- Demand output with CTPZ input
- Continuous output with CTPZ input
- Extended continuous output with CTPZ input
- SICS (level 0 and level 1)
- Variable access (COM1 only)

The COM1 port is also used when flashing new firmware to the terminal.

Demand Output Mode

The demand output mode transmits data only when the terminal receives a print request. Print requests are sent to the IND131 and IND331 terminals when:

- The operator presses PRINT
- A discrete input selected as print is triggered
- An ASCII "P" is sent through a demand or continuous port
- Auto print is enabled and all conditions for auto print are met
- A PLC command to print is received
- A print command is sent via shared variable access

When triggered, data is transmitted in a string programmed in the output template portion of setup. Demand mode is used typically when sending data to a printer or PC on a transactional basis.

Output Templates

The IND131 and IND331 terminals provide a choice of three different output formats (templates) to define the string of data to be transmitted. The scale ID field can also be added to any of these templates by a setup selection. The same data will be sent to both COM1 and COM2 if both ports are programmed for demand output. It is not possible to send a different data string from the two ports. Each line of data is terminated with a carriage <CR><LF>. Examples of each of the templates follow:

GTN – multiple line

29.94 kg
10.32 kg T
19.62 kg NET

Scale 1
29.94 kg
10.32 kg T
19.62 kg NET

GTN – single line

29.94 kg	10.32 kg T	19.62 kg NET
----------	------------	--------------

Scale 1	29.94 kg	10.32 kg T	19.62 kg NET
---------	----------	------------	--------------

Displayed weight (gross only – no tare) or (net weight – tare taken)

29.94 kg

Scale 1	29.94 kg
---------	----------

or

19.62 kg NET

Scale 1	19.62 kg NET
---------	--------------

Continuous Output Mode

The continuous output mode of the IND131 and IND331 terminals can be used to continuously send weight data and scale status information to a remote device such as a PC or a remote display.

Standard Continuous Output

Continuous Output can be assigned to COM1 or COM2. A checksum character can be enabled or disabled with continuous output. A data string will be output approximately 20 times per second for baud rates above 4800 baud. If a baud rate below 4800 is selected, the output rate will be slower. At 300 baud, the output rate is only approximately 2 per second. The data consists of 17 or 18 bytes as shown in Table C-1.

Non-significant weight data and tare data digits are transmitted as spaces. The continuous output mode provides compatibility with METTLER TOLEDO products that require real-time weight data. Table C-1 shows the format for the standard continuous output.

Table C-1: Standard Continuous Output Format

Character	Status ²				Indicated Weight ³						Tare Weight ⁴							
	1	2	3	4	5	6	7	8	9	10	11	12	13	14	15	16	17	18
Data	STX ¹	SWA	SWB	SWC	MSD	-	-	-	-	LSD	MSD	-	-	-	-	LSD	CR ⁵	CHK ⁶

■ Continuous Output Format Notes:

1. ASCII Start of Text character (02 hex), always transmitted.
2. Status words A, B and C. Refer to Table C-2, Table C-3, and Table C-4 for details of the structure.
3. Displayed weight. Either gross or net weight. Six digits, no decimal point or sign. Insignificant leading zeroes are replaced with spaces.
4. Tare weight. Six digits of tare weight data. No decimal point in field.
5. ASCII Carriage Return <CR> character (0D hex).
6. Checksum, transmitted only if enabled in setup. Checksum is used to detect errors in the transmission of data. Checksum is defined as the 2's complement of the seven low order bits of the binary sum of all characters preceding the checksum character, including the <STX> and <CR> characters.

Table C-2, Table C-3, and Table C-4 detail the status bytes for standard continuous output.

Table C-2: Status Word A Bit Definitions

Bits 2, 1, and 0			
2	1	0	Decimal Point Location
0	0	0	XXXXX00
0	0	1	XXXXX0
0	1	0	XXXXXX
0	1	1	XXXXX.X
1	0	0	XXXX.XX
1	0	1	XXX.XXX
1	1	0	XX.XXXX
1	1	1	X.XXXXX
Bits 4 and 3			
4	3		Build Code
0	1		X1
1	0		X2
1	1		X5
Bit 5			Always = 1
Bit 6			Always = 0

Table C-3: Status Word B Bit Definitions

Status Bits	Function
Bit 0	Gross = 0, Net = 1
Bit 1	Sign, Positive = 0, Negative = 1
Bit 2	Out of Range = 1 (Over capacity or Under Zero)
Bit 3	Motion = 1, Stable = 0
Bit 4	lb = 0, kg = 1 (see also Status Byte 3, bits 0-2)
Bit 5	Always = 1
Bit 6	Zero Not Captured after power-up = 1

Table C-4: Status Word C Bit Definitions

Bits 2, 1, and 0			Weight Description
2	1	0	
0	0	0	lb or kg, selected by Status Byte B, bit 4
0	0	1	grams (g)
0	1	0	metric tons (t)
0	1	1	not used
1	0	0	not used
1	0	1	not used
1	1	1	tons (ton)
1	1	1	no units
Bit 3			Print Request = 1
Bit 4			Expand Data x 10 = 1, Normal = 0
Bit 5			Always = 1
Bit 6			Always = 0

Continuous – Extended Output

The extended continuous output is a 24 byte message string that is an extension of the standard 17 bytes continuous output format. The additional bytes serve to provide a node address and, optionally, custom application bits. A checksum character is selectable.

The IND131 and IND331 terminals support only the point-to-point application of the extended continuous format. The multi-drop application is not supported.

Table C-5 describes the extended continuous output format. The output takes the form shown here:

<SOH><ADR><SB-1><SB-2><SB-3><SB-4><WWWWWWWWW><TTTTTTTT><CR><CKS>

Table C-5: Format of Continuous – Extended Output

Character	Status				Indicated Weight							Tare Weight													
	1	2	3	4	5	6	7	8	9	10	11	12	13	14	15	16	17	18	19	20	21	22	23	24	25
Data	SOH	ADR	SB1	SB2	SB3	SB4	W	W	W	W	W	W	W	W	W	T	T	T	T	T	T	T	T	CR	CKS
Note	A	B	C				D							E							F	G			

 Extended Continuous Output Format Notes

- A. ASCII Start of Header character <SOH> (01xh)
- B. Address character always present. The address is always "1" (31xh).
- C. Status Bytes 1 to 4. Refer to Table C-6, Table C-7, Table C-8 and Table C-9.

- D. Displayed weight (gross or net). Nine (9) ASCII digits including negative sign, decimal point. Leading zeros are set to spaces (20H). A minus sign (2DH) is sent immediately before the MSD for negative weights. Digits sent when data is invalid can be weight, zeros, or spaces (they should be ignored by receiving device). This field may also contain asynchronous error codes, when the data invalid bit is set.
- E. Tare weight. Eight (8) ASCII digits including decimal point. Leading zeros set to spaces (20xh).
- F. ASCII carriage return <CR> (0Dxh).
- G. Optional checksum. This character is the 2's complement of the sum of the 7 least significant bits of all preceding characters including the <SOH> and <CR>. The checksum character is transmitted with the same parity as all other characters.

Table C-6, Table C-7, Table C-8 and Table C-9 indicate the functions of status bytes 1, 2, 3 and 4.

Table C-6: Status Byte 1 Definitions

Bit 3	Bit 2	Bit 1	Bit 0	Units
0	0	0	0	None
0	0	0	1	pounds
0	0	1	0	kilograms
0	0	1	1	grams
0	1	0	0	metric tons
0	1	0	1	tons
0	1	1	0	Not used
0	1	1	1	Not used
1	0	0	0	Not used
1	0	0	1	Not used
1	0	1	0	Not used
1	0	1	1	Not used
1	1	0	0	Not used
1	1	0	1	Not used
1	1	1	0	Not used
1	1	1	1	Not used
Bit 4		Center of zero = 1		
Bit 5		Always = 1		
Bit 6		Weight in motion = 1		

Table C-7: Status Byte 2 Definitions

Bit	Description	
Bit 0	Gross or net mode, Net = 1	
Bit 2	Bit 1	Tare type
0	0	No tare
0	1	Semi-automatic tare
1	0	Preset tare
1	1	Not used
Bit 3	Always = 0	
Bit 4	Always = 0	
Bit 5	Always = 1	
Bit 6	Expanded by x10 = 1	

Table C-8: Status Byte 3 Definitions

Bit	Description
0	Data invalid = 1
1	Out of range under zero = 1
2	Out of range over capacity = 1
3	In power up (zero not captured) = 1
4	Print initiated = 1
5	Always = 1
6	Not used

Table C-9: Status Byte 4 Definitions

Bit	Description
0	Always = 0
1	Always = 0
2	Always = 0
3	Always = 0
4	Always = 0
5	Always = 1
6	Always = 0

◀ Additional Extended Continuous Output Notes

- The Data Invalid bit in Status Byte 3 indicates an overcapacity value, an under zero condition, or other conditions that indicate the weight value may not be valid. Any device reading the continuous output must monitor the Data Invalid bit and handle the data accordingly.

- The application bits in Status Byte 4 are used for specific functions by other terminals and are not use in the IND131 or IND331 terminals.
- In addition to setting the Data Invalid bit to 1 in Status Byte 3 when the weight data is not available, the indicated weight data field could be replaced with an asynchronous error code. The 9-character weight field is replaced with the following error code data format:

Indicated Weight Field Character	Description
1	Always "E" (45xh) indicating an error message
2 – 5	Error source
6 – 7	Error code
8 – 9	Space (20 Hex)

CTPZ

When a serial port is programmed as a demand, continuous or continuous extended output, the CTPZ input mode is automatically assigned. The CTPZ input mode provides a method for a remote serial device to trigger several basic functions when a command character is sent to the terminal. A termination character is not required. Remote ASCII command characters include:

- **C** – Clears the scale to gross
- **T** – Tares the scale (causes a pushbutton tare)
- **P** – Initiates a print command
- **Z** – Zeros the scale

All other characters are ignored.

◀ ASCII command characters must be sent in upper-case letters.

Example

To initiate a pushbutton tare, program the terminal for demand or continuous output for a specific port, program the serial port parameters to match the other device and then send the ASCII character "T".

Standard Interface Command Set (SICS) Protocol

The IND131 and IND331 terminals support the METTLER TOLEDO Standard Interface Command Set (MT-SICS), which is divided into four levels (0, 1, 2, 3), depending on the functionality of the device. These terminals support parts of levels 0 and 1:

- MT-SICS level 0 – Command set for the simplest device.
- MT-SICS level 1 – Extension of the command set for standard devices.

A feature of this interface is that the commands combined in MT-SICS level 0 and 1 are identical for all devices. Both the simplest weighing device and a fully expanded weighing workstation can recognize the commands of MT-SICS levels 0 and 1.

Version Number of the MT-SICS

Each level of the MT-SICS has its own version number, which can be requested with the command I1 from level 0. This terminal supports:

- MT-SICS level 0, version 2.2x (except the ZI command)
- MT-SICS level 1, version 2.2x (except the D, DW and K commands)

Command Formats

Each command received by the terminal via the SICS interface is acknowledged by a response to the transmitting device. Commands and responses are data strings with a fixed format. Commands sent to the terminal comprise one or more characters of the ASCII character set. Commands must be in upper-case.

The parameters of the command must be separated from one another and from the command name by a space (20xh), in the examples shown in this section, a space is represented as _).

Each command must be terminated by <CR>< LF> (0Dxh, 0Axh).

The characters <CR> and <LF>, which can be input using the **ENTER** or **RETURN** key of most PC terminal keypads, are not shown in this description; however, it is essential they be included for communication with the terminal.

Example

Command to tare the terminal:

"TA_20.00_lb" (The command terminators <CR>< LF> are not shown.)

Response Formats

All responses sent by the terminal to the transmitting device acknowledging the received commands have one of the following formats:

Response with weight value

Response without weight value

Error message

Format of the Response with Weight Value

A general description of the response with weight value as follows:



ID – Response identification.

— – Space (20xh)

Status – Status of the terminal. See description of the commands and responses.

Weight Value – Weighing result, which is shown as a number with 10 digits, including sign directly in front of the first digit. The weight value appears right justified. Preceding zeroes are suppressed with the exception of the zero to the left of the decimal point.

Unit – Weight unit displayed.

CR – Carriage Return (0Dxh.)

LF – Line Feed (0Axh)

Comment – the <CR> and <LF> characters will not be shown in this description.

Example

Response with a stable weight value of 0.256 kg:

S _ S _ _ _ _ _ 0.256 _ kg

Format of the Response Without Weight Value

A general description of the response without weight value is as follows:

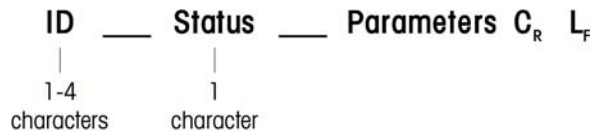

ID – Response identification.

— – Space (20xh)

Status – Status of the terminal. See description of the commands and responses.

Parameters – Command-dependent response code.

CR – Carriage Return (0Dxh)

LF – Line Feed (0Axh)

Comment – the <CR> and <LF> characters will not be shown in this description.

ID **C_R** **L_F**

Format of Error Message

There are three different error messages. The identification always comprises two characters:

ES – Syntax error

The terminal has not recognized the received command.

ET – Transmission error

The terminal has received a “faulty” command, such as a parity error.

EL – Logical error

The terminal cannot execute the received command.

CR – Carriage return (ODxh)

LF – Line Feed (OAxh)

Comment – the <CR> and <LF> characters will not be shown in this description.

Tips for the Programmer

Tips for creating a robust communication with the terminal using the SICS protocol include:

Command and Response

Improve the dependability of application software by having the program evaluate the response of the terminal to a command. The response is the acknowledgment that the terminal has received the command.

Reset

When establishing communication between the terminal and system, send a reset command to the terminal to enable a start from a determined state. When the terminal or system is switched on or off, faulty characters can be received or sent.

Quotation Marks (“ ”)

Quotation marks included in the command responses are used to designate fields and will always be sent.

Commands and Responses MT-SICS Level 0

The terminal receives a command from the system computer and acknowledges the command with an appropriate response. The following sections contain a

detailed description of the command set in alphabetical order with the associated responses. Commands and responses are terminated with <CR> and <LF>. These termination characters are not shown in the following description, but they must always be entered with commands or sent with responses.

The following commands of MT-SICS level 0 are supported:

- IO Inquiry of all implemented MT-SICS commands
- I1 Inquiry of MT-SICS level and MT-SICS versions
- I2 Inquiry of balance data
- I3 Inquiry of balance SW version and type definition number
- I4 Inquiry of serial number
- S Send stable weight value
- SI Send weight value immediately
- SIR Send weight value immediately and repeat
- Z Zero
- @ Reset (clear out serial buffer)

The following are detailed descriptions of these Level 0 commands:

IO – INQUIRY OF ALL IMPLEMENTED MT-SICS COMMANDS

Command:	IO	
Response:		IO_B_0_"IO" Level 0 "IO" command implemented
	IO_B_0_"I1"	Level 0 "I1" command implemented
	IO_B_0_"I2"	Level 0 "I2" command implemented
	IO_B_0_"I3"	Level 0 "I3" command implemented
	IO_B_0_"I4"	Level 0 "I4" command implemented
	IO_B_0_"S"	Level 0 "S" command implemented
	IO_B_0_"SI"	Level 0 "SI" command implemented
	IO_B_0_"SIR"	Level 0 "SIR" command implemented
	IO_B_0_"Z"	Level 0 "Z" command implemented
	IO_B_0_"@"	Level 0 "@" command implemented
	IO_B_0_"SR"	Level 1 "SR" command implemented
	IO_B_0_"T"	Level 1 "T" command implemented
	IO_B_0_"TA"	Level 1 "TA" command implemented
	IO_B_0_"TAC"	Level 1 "TAC" command implemented
Response:		IO_A_1_"TI" Level 1 "TI" command implemented (last command)
Response:	IO_I	Cannot execute command at this time.

I1 – INQUIRY OF MT-SICS LEVEL AND MT-SICS VERSIONS

Command: I1

Response: I1_A_ " " "2.2x" "2.2x" " " " "

"" No Levels fully implemented

2.2x Level 0, version V2.2x

2.2x Level 1, version V2.2x

"" No MT-SICS 2 commands

"" No MT-SICS 3 commands

Response: I1_I Command understood, not executable at present.

Comments

- For the MT-SICS level, only fully implemented levels are listed. In this case, neither level 0 nor level 1 were fully implemented so the level is not specified.
- In the case of the MT-SICS version, all levels are specified even those only partially implemented.

I2 – INQUIRY OF DATA

Command: I2

Response: I2_A_ "IND131,IND331_Standard_50.00_kg"

IND131,IND331 Model number of terminal

Standard Standard functionality

50.00 kg Capacity and primary unit of the scale

Response: I2_I Command understood, not executable at present.

Comments

- The number of characters in the "text" field depends on the scale capacity.

I3 – INQUIRY OF SW VERSION

Command: I3

Response: I3_A_ "1.00"

1.00 Firmware version of the terminal

Response: I3_I Command understood, not executable at present.

Comment

- The number of characters of "text" depends on the revision level.

I4 – INQUIRY OF SERIAL NUMBER

Command: I4

Response: I4_A_ "123456"

123456 Serial number of terminal

Response: I4_I Command understood, not executable at present.

Comments

- The serial number response is the content of the terminal serial number variable (#301) as entered in setup.

S – SEND STABLE WEIGHT VALUE

Command: S

Response: S_S_ _ _ _ _ 436.2_lb

436.2 stable displayed weight

lb weight unit

Response: S_I Command understood, not executable at present.

Response: S_+ Terminal in overload range.

Response: S_- Terminal in underload range.

Comments

- The terminal will wait for up to 3 seconds after receiving an "S" command for no-motion. If motion does not settle within this time, the command is aborted and the S_I response is sent.

SI – SEND WEIGHT VALUE IMMEDIATELY

Command: SI

Response: S_S_ _ _ _ _ 436.2_lb Stable weight value.

Response: S_D_ _ _ _ _ 436.2_lb Non-stable (dynamic) weight value.

Response: S_I Command understood, not executable at present.

Response: S_+ Terminal in overload range.

Response: S_- Terminal in underload range.

Comments

- The response to the command SI is the last internal weight value (stable or dynamic) before receipt of the "SI" command.

SIR – SEND WEIGHT VALUE IMMEDIATELY AND REPEAT

Command: SIR

Response: S_S_ _ _ _ _ 436.2_lb Stable weight value.

Response: S_D_ _ _ _ _ 436.2_lb Non-stable (dynamic) weight value.

Response: S_I Command understood, not executable at present.

Response: S_+ Terminal in overload range.

Response: S_- Terminal in underload range

Example

Command: SIR

Response: S_D_ _ _ _ _ 129.07_kg

S_D_ _ _ _ _ 129.09_kg

S_S_ _ _ _ _ 129.09_kg

S_S_ _ _ _ _ 129.09_kg

S_D_ _ _ _ _ 114.87_kg

. . . The scale continues to send stable or dynamic weight values

Comments

- The SIR command is overwritten and cancelled by the commands S, SI, SR, and @.
- The data output rate is approximately 10 per second.

Z – ZERO

Command: Z

Response: Z_A Command performed, meaning the scale was in gross mode, scale was stable and weight was within the zero capture range.

Response: Z_I Command understood, not executable at present.

Response: Z_+ Upper limit of zero setting range exceeded.

Response: Z_- Lower limit of zero setting range exceeded.

Comments

- The calibrated zero point determined during calibration is not influenced by this command.
- The terminal will wait for up to 3 seconds after receiving an "Z" command for no-motion. If motion does not settle within this time, the command is aborted and the Z_I response is sent.

@ – RESET

Command: @

Response: I4_A_“12345678”

12345678 Serial number of the scale

Comments

- Resets the scale to the condition found after switching on, but without a zero setting being performed.
- All commands awaiting responses are canceled.
- The tare register is cleared.
- The SIR and SR commands are cancelled.
- The Reset command is always executed except that a Reset command received by the terminal during the calibration and test procedure cannot be processed.

Commands and Responses MT-SICS Level 1

The following commands of MT-SICS level 1 are available:

SR	Send weight value on weight change (Send and Repeat)
T	Tare
TA	Set or inquiry of preset tare value
TAC	Clear tare value
TI	Tare Immediately

SR – SEND WEIGHT VALUE ON WEIGHT CHANGE (SEND AND REPEAT)

Command: SR_Value_Unit

SR

Response: S_S_ _ _ _ _ 105.1_lb Current stable weight.
 S_D_ _ _ _ _ 106.7_lb Dynamic weight value.
 S_S_ _ _ _ _ 124.3_lb Next stable weight value.

Response: S_I Command understood, not executable at present.

Response: S_L Command understood, invalid parameter.

Response: S_+ Terminal in overload range.

Response: S_- Terminal in underload range.

Example

Command: SR_0.50_kg Send the current stable weight value followed by every load change ≥ 0.50 kg.

Response: S_S_ _ _ _ _ 100.00_kg Scale stable.
 S_D_ _ _ _ _ 115.23_kg More than 0.50 kg loaded.
 S_S_ _ _ _ _ 200.00_kg Scale stable again.

Comments

- Command to send the current stable weight once then continuously after every weight change greater or equal to the "value" a non-stable (dynamic) value followed by the next stable value. If no preset value is included, the weight change must be at least 12.5% of the last stable weight value and a minimum of 30d.
- SR is overwritten and cancelled by the commands S, SI, SIR, @ and hardware break.
- If, following a non-stable (dynamic) weight value, stability has not been reached within the 3 second timeout interval, the response "S_I" is sent and then a non-stable weight value. Timeout then starts again from the beginning.
- The range value must be entered in primary units and must be in the range of 1d to capacity.

T – TARE

Command: T

Response: T_S_ _ _ _ _ 100.00_kg Tare performed, meaning the scale was stable and weight was within the weighing range.

Response: T_I Command understood, not executable at present.

Response: T_+ Upper limit of zero setting range exceeded.

Response: T_- Lower limit of zero setting range exceeded.

Comments

- The existing tare will be overwritten and replaced by the new preset tare weight value.
- The terminal will wait for up to 3 seconds after receiving a "T" command for no-motion. If motion does not settle within this time, the command is aborted and the T_I response is sent.

TA – INQUIRE/ENTER TARE VALUE

Command: TA Inquiry of tare weight value

TA_Tare Preset Value_Unit Entry of a preset tare value.

Response: TA_A_TareWeight/Value_Unit Current Tare weight value.

Response: TA_I Current Tare weight value cannot be transferred (the terminal is currently executing another command, such as zero setting).

Response: TA_L Command understood, invalid parameter.

Example

Command: TA_10.00_kg Load a preset tare of 10 kg.

Response: TA_A_ _ _ _ _10.00_kg The 10.00 kg tare value was accepted.

Comments

- The existing tare will be overwritten and replaced by the new preset tare weight value.
- The terminal will automatically round the tare value to the current readability.
- The preset value must be entered in primary units.

TAC – CLEAR TARE VALUE

Command: TAC

Response: TAC_A Tare value cleared.

Response: TAC_I Command understood, not executable at present.

TI – TARE IMMEDIATELY

Command: TI

Response:	TI_S_WeightValue_Unit	Taring performed, stable tare value.
Response:	TI_D_WeightValue_Unit	Taring performed, non-stable (dynamic) tare value.
Response:	TI_I	Command understood, not executable at present.
Response:	TI_L	The command is not executable.
Response:	TI_+	Upper limit of taring range exceeded.
Response:	TI_-	Lower limit of taring range exceeded.

Example

Command: TI
Response: TI_D_ _ _ _ 117.57_kg Tare taken with dynamic weight value.

Comments

- Any previous tare value will be overwritten by the new tare weight value.
- Tare weight values determined during motion may not be accurate.
- The tare weight value is sent in the current units.

Variable Access

All setup parameters and a few triggers and statuses in the terminal are available through a connection called "Variable Access". This is a serial interface assignment on COM1 that permits remote clients to send and receive commands and data from the terminal.

Connection

In order to access the variables in the IND131 and IND331 terminals, the COM1 port must be used and it must be assigned as Variable Access in the connection menu of setup.

Make sure the serial port of the remote device matches the parameters selected for the COM1 port. This includes the baud rate, data bits, parity bit, and 1 stop bit.

Connect an RS-232 cable between the remote client PC and the COM1 port of the IND131 or IND331 terminal.

Open a program to communicate with the terminal (such as HyperTerminal). Refer to the Commands section to understand how the commands should be structured.

Commands

The IND331 supports two commands - Read and Write. Some variables are read only and some can be both read and written. A response is always sent after a Read request or a Write command. If a valid format and variable are requested in a

Read, Response 1 from below will be sent. If the format is incorrect or a bad variable name is requested, an error like Response 2 will be sent. A Write command will receive either an acknowledge (ASCII <ACK> - 06xh) for an accepted command or a negative acknowledgement (ASCII <NAK> - 15xh) for an invalid command or data.

A Space character is required between the index number and data that is being sent. This character is shown as <SP> (20xh) in the examples. All commands and responses are terminated with a Carriage Return and a Line Feed character. These characters are shown as <CR><LF> (0Dxh, 0Axh).

Individual Variables

The PC program can connect with the IND131 or IND331 terminal to read and write specific variables per the following examples. The list of index numbers is given in the next section.

Read request: R(index#)<CR><LF>
Read filter value: R119<CR><LF>
Response 1 (valid): R119<SP>1<CR><LF>
Read filter value: R179<CR><LF>
Response 2 (error): R179<SP> Error: Invalid Request<CR><LF>

Write request: W(index#)<SP>xxxxx<CR><LF>
Write target value : W611<SP>42.75<CR><LF>
Response 1 (valid): <ACK><CR><LF> (data is accepted)
Response 2 (error): <NAK><CR><LF> (data or variable is invalid)

Blocks of Variables

An entire block of data can be read or written at one time by using the index of an entire block (such as 100, 200, etc.). Each field in the block is separated with the “^” symbol (5Eh). If no data is to be changed in a specific field, that field can be left empty (no new data).

Block read request: R(index#)<CR><LF>
Read target block: R610<CR><LF>
Response 1 (valid): R610<SP>62.00^0.03^0.04^1.20^4.8<CR><LF>
Read target block: R650<CR><LF>
Response 2 (error): R650<SP>Error: Invalid Request<CR><LF>

The block write example will download a new target (50.00), -tol (0.05), +tol (0.08) and fine feed (5.30) and use previous spill value.

Block write request: W(index#)<SP>xx^xx^xx<CR><LF>
 Write target value: W610<SP>50.00^0.05^0.08^^5.30<CR><LF>
 Response 1: <ACK><CR><LF>
 Response 2: <NAK><CR><LF> (if data or variable is invalid)

Variable List

The following groups of variables are supported in the IND131 and IND331 terminals.

Scale Status (read only)

Index	Name	Description	Notes	
000	Scale Status Block	Entire Scale Status Block		
001	Displayed Weight	Format: weight<SP>unit. Weight is always 8 characters (including decimal) with leading spaces and unit is always 3 characters.	Weight unit is included.	
002	Scale Status	b0	0 – gross mode 1 – net mode	This character is the same as status byte B in the continuous output string.
		b1	0 – positive weight 1 – negative weight	
		b2	0 – in normal weighing range 1 – out of range (over capacity or under zero)	
		b3	0 – no motion 1 – motion	
		b4	0 – lb, g, t, ton 1 – kg	
		b5	Always "1"	
		b6	0 – zero not captured since power up 1 – zero captured after power up	
		b7	Always "1"	
003	Tare Weight	Format: weight<SP>unit. Weight is always 8 characters (including decimal) with leading spaces and unit is always 3 characters.	Weight unit is included.	
004	Raw Counts	Format: always 7 digits with leading zeroes.		

Index	Name	Description	Notes
005	Rate	Format: rate<SP>unit. Rate is always 10 characters (including decimal) with leading space and unit is always 5 characters.	

DIO and Target Status (read only)

Index	Name	Description	Notes	
010	DIO & Target Status Block	Entire DIO & Target Status Block		
011	DIO Inputs – Status	b0	In 1, 0 – OFF, 1 – ON	
		b1	In 2, 0 – OFF, 1 – ON	
		b2-b5	Always “0”	
		b6-b7	Always “1”	
012	DIO Outputs Status	b0	Out 1, 0 – OFF, 1 – ON	
		b1	Out 2, 0 – OFF, 1 – ON	
		b2	Out 3, 0 – OFF, 1 – ON	
		b3	Out 4, 0 – OFF, 1 – ON	
		b4-b5	Always “0”	
		b6-b7	Always “1”	
013	Target Status	b0	Fast Feed, OFF – 0, ON – 1	
		b1	Feed, OFF – 0, ON – 1	
		b2	In Tolerance, 0 – OUT, 1 – IN	
		b3	Comparator 1, OFF – 0, ON – 1	
		b4	Comparator 2, OFF – 0, ON – 1	
		b5	Comparator 3, OFF – 0, ON – 1	
		b6-b7	Always “1”	

Terminal Commands (write only)

Index	Name	Description	Notes
031	Keypad Commands	Z – Zero Scale T – Tare Scale C – Clear Scale P – Print	
032	Output 1 Control	0 – Turn DIO Output 1 OFF 1 – Turn DIO Output 1 ON	
033	Output 2 Control	0 – Turn DIO Output 2 OFF 1 – Turn DIO Output 2 ON	

Index	Name	Description	Notes
034	Output 3 Control	0 – Turn DIO Output 3 OFF 1 – Turn DIO Output 3 ON	
035	Output 4 Control	0 – Turn DIO Output 4 OFF 1 – Turn DIO Output 4 ON	
036	Target Control Commands	S – Target Start (reads target values then starts) R – Resume (uses previous target values) P – Pause target A – Abort target	
037	Restart Terminal	1 – Restart Terminal	
040	Zero Adjustment	1 – Trigger Zero Adjustment	
041	SPAN 1 adjustment	1 – Trigger SPAN 1 adjustment	
042	SPAN 2 adjustment	1 – Trigger SPAN 2 adjustment	Used when linearity is enabled as the middle span point

Setup – Scale (read and write)

Index	Name	Description
100	Scale Block	Entire Scale Block
101	Scale Name	20 characters max. No entry on terminal.
102	Approval Type	0 – None 1 – USA 2 – OIML 3 – Canada
103	Unit	0 – None 1 – g 2 – kg 3 – lb 4 – t 5 – ton
104	Capacity	Manual Entry

IND131/IND331 Terminals User's Guide

Index	Name	Description
105	Increment Size	0 – 0.001 1 – 0.002 2 – 0.005 3 – 0.01 4 – 0.02 5 – 0.05 6 – 0.1 7 – 0.2 8 – 0.5 9 – 1 10 – 2 11 – 5 12 – 10 13 – 20 14 – 50 15 – 100
106	X10 Always	0 – Disabled 1 – Enabled
107	Linearity	0 – Disabled 1 – Enabled
108	Auto Zero	0 – Disabled 1 – Gross 2 – Gross & Net
109	Auto Zero Range	0 – 0.5d 1 – 1d 2 – 3d 3 – 10d
110	Under Zero Blanking	0 – Disabled 1 – 5d always
112	Pushbutton Zero	0 – Disabled 1 – $\pm 2\%$ 2 – $\pm 20\%$
113	Pushbutton Tare	0 – Disabled 1 – Enabled
114	Net Sign Correction	0 – Disabled 1 – Enabled
115	Rate Units	0 – None 1 – Primary
116	Time Units	0 – Seconds 1 – Minutes 2 – Hours
117	Measurement Period	0 – 0.5s 1 – 1s 2 – 5s
118	Output Average	0 – 1s 1 – 5s 2 – 10s 3 – 30s 4 – 60s
119	Low Pass Filter	0 – Light 1 – Medium 2 – Heavy

Index	Name	Description
120	Stability Filter	0 – Disabled 1 – Enabled
121	Motion Range	0 – Disabled 1 – 1d 2 – 3d
122	Auto Print	0 – Disabled 1 – After target

Setup – Application (read and write)

Index	Name	Description
200	Application Block	Entire Application Block
201	Tolerance Type	0 – Weight Deviation 1 – % of Target
202	Output Type	0 – Concurrent 1 – Independent
203	Target Source	0 – Displayed weight 1 – Gross weight
204	Target Latching	0 – Disabled 1 – Enabled
205	Comparator 1 Source	0 – Disabled 1 – Displayed weight 2 – Gross Weight 3 – Rate
206	Comparator 1 Active	0 – < (less than) 1 – <= (less than or equal to) 2 – = (equal to) 3 – > (greater than) 4 – >= (greater than or equal to) 5 – <> (not equal to) 6 – _<>_ (outside range: less than Limit or greater than High Limit) 7 – >_<_ (inside range: greater than Limit and less than High Limit)
207	Comparator 2 Source	Same as Comparator 1 Source
208	Comparator 2 Active	Same as Comparator 1 Active
209	Comparator 3 Source	Same as Comparator 1 Source
210	Comparator 3 Active	Same as Comparator 1 Active
211	Input 1 Polarity	0 – + True 1 – - True
212	Input 1 Assignment	0 – None 1 – Clear Tare 2 – Keypad disabled 3 – Print 4 – Tare 5 – Target Abort 6 – Target Start
213	Input 2 Polarity	0 – + True 1 – - True
214	Input 2 Assignment	Same as Input 1 Assignment

Index	Name	Description
215	Output 1 Assignment	0 – None 1 – Center of Zero 2 – Comparator 1 3 – Comparator 2 4 – Comparator 3 5 – Fast Feed 6 – Feed 7 – In Tolerance 8 – Motion 9 – Net 10 – Over capacity 11 – Under Zero
216	Output 2 Assignment	Same as Output 1 Assignment
217	Output 3 Assignment	Same as Output 1 Assignment
218	Output 4 Assignment	Same as Output 1 Assignment

Setup – Terminal (read and write)

Index	Name	Description
300	Terminal Block	Entire Terminal Block
301	Serial Number	Manual Entry - 8 digits max
302	Screen Saver	0 – Disabled 1 – 1 minute 2 – 5 minutes 3 – 10 minutes
303	Menu Language	0 – English 1 – "F" code 2 – French 3 – German 4 – Italian 5 – Spanish
304	Setup Language	0 – English 1 – "F" codes
305	Calibration Access	0 – Disabled 1 – Enabled
306	Target Access	0 – Disabled 1 – Enabled
307	Comparators Access	0 – Disabled 1 – Enabled
308	Password Protect	0 – Disabled 1 – Enabled
309	Password	Manual entry – 6 digits
310	ID1	PC tool input 20 characters
311	ID2	PC tool input 20 characters
312	ID3	PC tool input 20 characters
313	Service Number	PC tool input 20 characters
314	Base Serial Number	PC tool input 15 characters

Setup – Communication (read and write)

Index	Name	Description
400	Communication Serial Block	Entire Communication Block
401	Format	0 – Displayed Weight Only 1 – G-T-N Single Line 2 – G-T-N Multiple Lines
402	Print Scale Name	0 – Disabled 1 – Enabled
403	COM1 Assignment	0 – None 1 – Continuous Output 2 – Continuous-Extended Output 3 – Demand Output 4 – SICS 5 – Variable Access
404	COM1 Checksum	0 – Disabled 1 – Enabled
405	COM2 Assignment	Same as COM1 Assignment
406	COM2 Checksum	Same as COM1 Checksum
407	COM1 Baud Rate	0 – 300 1 – 600 2 – 1200 3 – 2400 4 – 4800 5 – 9600 6 – 19200 7 – 38400 8 – 57600 9 – 115200
408	COM1 Data Bits	0 – 7 1 – 8
409	COM1 Parity	0 – None 1 – Even 2 – Odd
411	COM2 Baud rate	0 – 300 1 – 600 2 – 1200 3 – 2400 4 – 4800 5 – 9600 6 – 19200 7 – 38400 8 – 57600 9 – 115200
412	COM2 Data Bits	0 – 7 1 – 8
413	COM2 Parity	0 – None 1 – Even 2 – Odd
415	COM2 Interface	0 – RS232 1 – RS485

Setup – Communication – PLC (read and write)

Index	Name	Description
450	Communication PLC Block	Entire Communication PLC Block
451	Analog - Source	0 – None 1 – Displayed Weight 2 – Gross Weight 3 – Rate
452	Analog – Zero Value	Manual Entry
453	Analog – Full Scale Value	Manual Entry
454	Node Address	A-B RIO : 0 ~ 62 PROFIBUS : 1 ~ 125 DeviceNet : 0 ~ 63
455	Operation Mode	Do not use
456	Data Format	0 – Division 1 – Floating point 2 – Integer
457	RIO – Start Quarter	1 – 1 2 – 2 3 – 3 4 – 4
458	RIO - Last Rack	0 – Disabled 1 – Enabled
459	RIO – Data Rate	0 – 57600 1 – 115200 2 – 230400
460	DeviceNet - Rate	0 – 125K 1 – 250K 2 – 500K
461	DHCP Client	0 – Disabled 1 – Enabled
462	IP Address	xxx.xxx.xxx.xxx
463	Subnet Address	xxx.xxx.xxx.xxx
464	Gateway Address	xxx.xxx.xxx.xxx
465	Analog output 4mA Preset	Obtained during Calibration
466	Analog output 20mA Preset	Obtained during Calibration
468	Byte Order	0 – Byte swap 1 – Historic / Standard 2 – Word swap 3 – Double word swap

Setup – Maintenance (read only)

Index	Name	Description
500	Maintenance Block	Entire Maintenance Block
501	Weighment Counter	
502	Scale Overloads Counter	
503	Peak Weight	

Index	Name	Description
504	Zero Commands Counter	
505	Zero Command Failure Counter	

Calibration Values (read and write)

Index	Name	Description
600	Calibration Block	Entire set of Calibration Values
601	Zero Counts	Zero counts
602	Test Load 1	Test weight value for load 1
603	Test Load 1 Counts	Test load 1 counts
604	Test Load 2	Test weight value for load 2. Used when linearity is enabled
605	Test Load 2 Counts	Test load 2 counts. Used when linearity is enabled

Target Values (read and write)

Index	Name	Description
610	Target Block	Entire set of Target Values
611	Target	Target value
612	-Tol	-Tolerance value
613	+Tol	+Tolerance value
614	Spill	Spill value
615	Fine Feed	Fine Feed value

Comparator Values (read and write)

Index	Name	Description
620	Comparator Block	Entire set of Comparator Values
621	Comparator 1 Limit	Comparator 1 Limit
622	Comp. 1 High Limit	Comparator 1 High Limit
623	Comparator 2 Limit	Comparator 2 Limit
624	Comp. 2 High Limit	Comparator 2 High Limit
625	Comparator 3 Limit	Comparator 3 Limit
626	Comp. 3 High Limit	Comparator 3 High Limit

METTLER TOLEDO

1900 Polaris Parkway
Columbus, Ohio 43240

METTLER TOLEDO[®] is a registered
trademark of Mettler-Toledo, Inc.

©2009 Mettler-Toledo, Inc.



64067481